

LM4562

Dual High Performance, High Fidelity Audio Operational Amplifier

General Description

The LM4562 is part of the ultra-low distortion, low noise, high slew rate operational amplifier series optimized and fully specified for high performance, high fidelity applications. Combining advanced leading-edge process technology with state-of-the-art circuit design, the LM4562 audio operational amplifiers deliver superior audio signal amplification for outstanding audio performance. The LM4562 combines extremely low voltage noise density ($2.7\text{nV}/\sqrt{\text{Hz}}$) with vanishingly low THD+N (0.00003%) to easily satisfy the most demanding audio applications. To ensure that the most challenging loads are driven without compromise, the LM4562 has a high slew rate of $\pm 20\text{V}/\mu\text{s}$ and an output current capability of $\pm 26\text{mA}$. Further, dynamic range is maximized by an output stage that drives $2\text{k}\Omega$ loads to within 1V of either power supply voltage and to within 1.4V when driving 600Ω loads.

The LM4562's outstanding CMRR (120dB), PSRR (120dB), and V_{OS} (0.1mV) give the amplifier excellent operational amplifier DC performance.

The LM4562 has a wide supply range of $\pm 2.5\text{V}$ to $\pm 17\text{V}$. Over this supply range the LM4562's input circuitry maintains excellent common-mode and power supply rejection, as well as maintaining its low input bias current. The LM4562 is unity gain stable. This Audio Operational Amplifier achieves outstanding AC performance while driving complex loads with values as high as 100pF .

The LM4562 is available in 8-lead narrow body SOIC, 8-lead Plastic DIP and 8-lead Metal Can TO-99. Demonstration boards are available for each package.

Key Specifications

- Power Supply Voltage Range $\pm 2.5\text{V}$ to $\pm 17\text{V}$

■ THD+N ($A_V = 1$, $V_{\text{OUT}} = 3V_{\text{RMS}}$, $f_{\text{IN}} = 1\text{kHz}$)	
$R_L = 2\text{k}\Omega$	0.00003% (typ)
$R_L = 600\Omega$	0.00003% (typ)
■ Input Noise Density	$2.7\text{nV}/\sqrt{\text{Hz}}$ (typ)
■ Slew Rate	$\pm 20\text{V}/\mu\text{s}$ (typ)
■ Gain Bandwidth Product	55MHz (typ)
■ Open Loop Gain ($R_L = 600\Omega$)	140dB (typ)
■ Input Bias Current	10nA (typ)
■ Input Offset Voltage	0.1mV (typ)
■ DC Gain Linearity Error	0.000009%

Features

- Easily drives 600Ω loads
- Optimized for superior audio signal fidelity
- Output short circuit protection
- PSRR and CMRR exceed 120dB (typ)
- SOIC, DIP, TO-99 metal can packages

Applications

- Ultra high quality audio amplification
- High fidelity preamplifiers
- High fidelity multimedia
- State of the art phono pre amps
- High performance professional audio
- High fidelity equalization and crossover networks
- High performance line drivers
- High performance line receivers
- High fidelity active filters

Typical Application

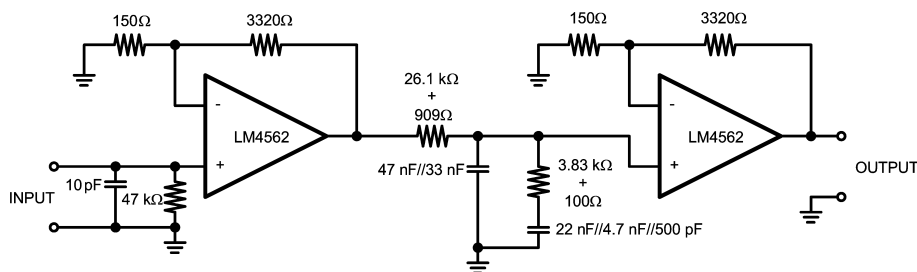

Note: 1% metal film resistors, 5% polypropylene capacitors

Passively Equalized RIAA Phono Preamplifier

201572K5

Connection Diagrams

Dual-In-Line Package

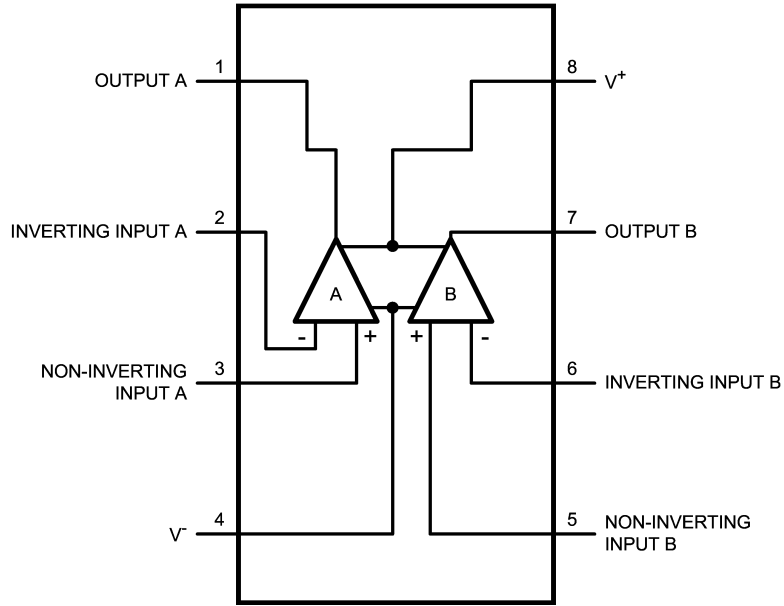

20157255

Order Number LM4562MA
 See NS Package Number — M08A
 Order Number LM4562NA
 See NS Package Number — N08E

Metal Can

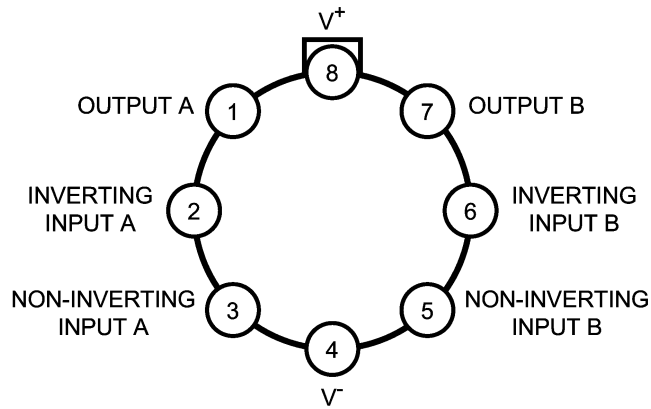

201572F3

Order Number LM4562HA
 See NS Package Number — H08C

Absolute Maximum Ratings (Notes 1, 2)

If Military/Aerospace specified devices are required, please contact the National Semiconductor Sales Office/Distributors for availability and specifications.

Power Supply Voltage ($V_S = V^+ - V^-$)	36V
Storage Temperature	-65°C to 150°C
Input Voltage (V-) - 0.7V to (V+) + 0.7V	
Output Short Circuit (Note 3)	Continuous
Power Dissipation	Internally Limited

ESD Susceptibility (Note 4)	2000V
ESD Susceptibility (Note 5)	
Pins 1, 4, 7 and 8	200V
Pins 2, 3, 5 and 6	100V
Junction Temperature	150°C
Thermal Resistance	
θ_{JA} (SO)	145°C/W
θ_{JA} (NA)	102°C/W
θ_{JA} (HA)	150°C/W
θ_{JC} (HA)	35°C/W
Temperature Range	
$T_{MIN} \leq T_A \leq T_{MAX}$	-40°C \leq T_A \leq 85°C
Supply Voltage Range	$\pm 2.5V \leq V_S \leq \pm 17V$

Electrical Characteristics for the LM4562 (Note 1)

The following specifications apply for the circuit shown in Figure X. $V_S = \pm 15V$, $R_L = 2k\Omega$, $R_{SOURCE} = 10\Omega$, $f_{IN} = 1kHz$, and $T_A = 25^\circ C$, unless otherwise specified.

Symbol	Parameter	Conditions	LM4562		Units (Limits)
			Typical	Limit	
			(Note 6)	(Note 7)	
THD+N	Total Harmonic Distortion + Noise	$A_V = 1$, $V_{OUT} = 3V_{rms}$ $R_L = 2k\Omega$ $R_L = 600\Omega$	0.00003 0.00003	0.00009	% (max)
IMD	Intermodulation Distortion	$A_V = 1$, $V_{OUT} = 3V_{RMS}$ Two-tone, 60kHz & 7kHz 4:1	0.00005		dB
GBWP	Gain Bandwidth Product		55	45	MHz (min)
SR	Slew Rate		± 20	± 15	V/ μs (min)
FPBW	Full Power Bandwidth	$V_{OUT} = 1V_{P-P}$, -3dB referenced to output magnitude at $f = 1kHz$	10		MHz
t_s	Settling time	$A_V = -1$, 10V step, $C_L = 100pF$ 0.1% error range	1.2		μs
e_n	Equivalent Input Noise Voltage	$f_{BW} = 20Hz$ to 20kHz	0.34	0.65	μV_{RMS} (max)
	Equivalent Input Noise Density	$f = 1kHz$ $f = 10Hz$	2.7 6.4	4.7	nV/ \sqrt{Hz} (max)
i_n	Current Noise Density	$f = 1kHz$	1.6		pA/ \sqrt{Hz}
		$f = 10Hz$	3.1		
V_{OS}	Offset Voltage		± 0.1	± 0.7	mV (max)
$\Delta V_{OS}/\Delta Temp$	Average Input Offset Voltage Drift vs Temperature	-40°C \leq T_A \leq 85°C	0.2		$\mu V/^\circ C$
PSRR	Average Input Offset Voltage Shift vs Power Supply Voltage	$\Delta V_S = 20V$ (Note 8)	120	110	dB (min)
ISO_{CH-CH}	Channel-to-Channel Isolation	$f_{IN} = 1kHz$	118		dB
		$f_{IN} = 20kHz$	112		
I_B	Input Bias Current	$V_{CM} = 0V$	10	72	nA (max)
$\Delta I_{OS}/\Delta Temp$	Input Bias Current Drift vs Temperature	-40°C \leq T_A \leq 85°C	0.1		nA/ $^\circ C$
I_{OS}	Input Offset Current	$V_{CM} = 0V$	11	65	nA (max)
V_{IN-CM}	Common-Mode Input Voltage Range		+14.1 -13.9	(V+) - 2.0 (V-) + 2.0	V (min)
CMRR	Common-Mode Rejection	-10V < V_{cm} < 10V	120	110	dB (min)

Electrical Characteristics for the LM4562 (Note 1)

The following specifications apply for the circuit shown in Figure X. $V_S = \pm 15V$, $R_L = 2k\Omega$, $R_{SOURCE} = 10\Omega$, $f_{IN} = 1kHz$, and $T_A = 25^\circ C$, unless otherwise specified. (Continued)

Symbol	Parameter	Conditions	LM4562		Units (Limits)
			Typical	Limit	
			(Note 6)	(Note 7)	
Z_{IN}	Differential Input Impedance		30		$k\Omega$
	Common Mode Input Impedance	$-10V < V_{cm} < 10V$	1000		$M\Omega$
A_{VOL}	Open Loop Voltage Gain	$-10V < V_{out} < 10V$, $R_L = 600\Omega$	140	125	dB (min)
		$-10V < V_{out} < 10V$, $R_L = 2k\Omega$	140		
		$-10V < V_{out} < 10V$, $R_L = 10k\Omega$	140		
V_{OUTMAX}	Maximum Output Voltage Swing	$R_L = 600\Omega$	± 13.6	± 12.5	V (min)
		$R_L = 2k\Omega$	± 14.0		
		$R_L = 10k\Omega$	± 14.1		
I_{OUT}	Output Current	$R_L = 600\Omega$, $V_S = \pm 17V$	± 26	± 23	mA (min)
I_{OUT-CC}	Instantaneous Short Circuit Current		+53 -42		mA
R_{OUT}	Output Impedance	$f_{IN} = 10kHz$ Closed-Loop	0.01		Ω
		Open-Loop	13		
C_{LOAD}	Capacitive Load Drive Overshoot	100pF	16		%
I_S	Total Quiescent Current	$I_{OUT} = 0mA$	10	12	mA (max)

Note 1: *Absolute Maximum Ratings* indicate limits beyond which damage to the device may occur.

Note 2: *Operating Ratings* indicate conditions for which the device is functional, but do not guarantee specific performance limits. For guaranteed specifications and test conditions, see the Electrical Characteristics. The guaranteed specifications apply only for the test conditions listed. Some performance characteristics may degrade when the device is not operated under the listed test conditions.

Note 3: Amplifier output connected to GND, any number of amplifiers within a package.

Note 4: Human body model, 100pF discharged through a 1.5k Ω resistor.

Note 5: Machine Model ESD test is covered by specification EIAJ IC-121-1981. A 200pF cap is charged to the specified voltage and then discharged directly into the IC with no external series resistor (resistance of discharge path must be under 50 Ω).

Note 6: Typical specifications are specified at +25 $^\circ C$ and represent the most likely parametric norm.

Note 7: Tested limits are guaranteed to National's AOQL (Average Outgoing Quality Level).

Note 8: PSRR is measured as follows: V_{OS} is measured at two supply voltages, $\pm 5V$ and $\pm 15V$. $PSRR = |20\log(\Delta V_{OS}/\Delta V_S)|$.

Typical Performance Characteristics

THD+N vs Output Voltage

$V_{CC} = 15V, V_{EE} = -15V$
 $R_L = 2k\Omega$

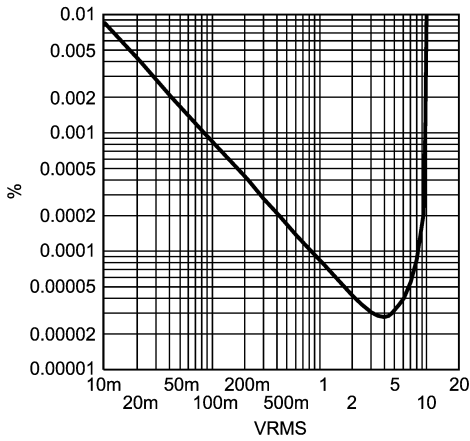

20157275

THD+N vs Output Voltage

$V_{CC} = 12V, V_{EE} = -12V$
 $R_L = 2k\Omega$

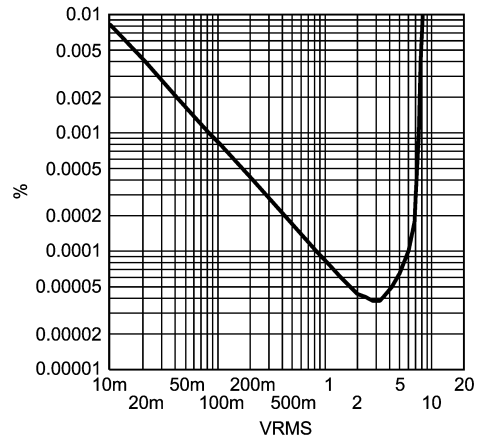

20157274

THD+N vs Output Voltage

$V_{CC} = 17V, V_{EE} = -17V$
 $R_L = 2k\Omega$

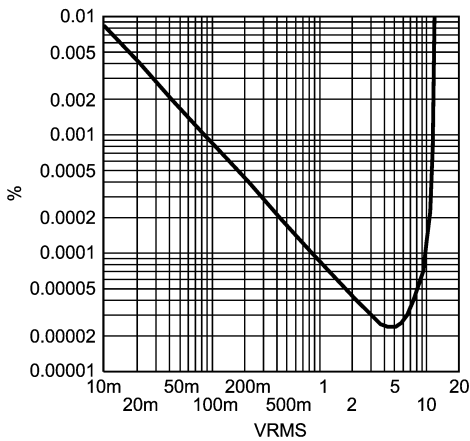

20157276

THD+N vs Output Voltage

$V_{CC} = 2.5V, V_{EE} = -2.5V$
 $R_L = 2k\Omega$

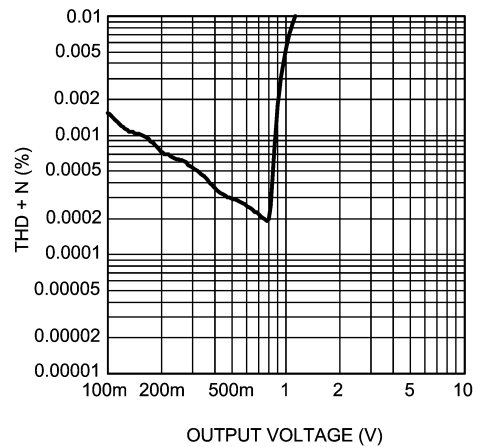

20157214

THD+N vs Output Voltage

$V_{CC} = 15V, V_{EE} = -15V$
 $R_L = 600\Omega$

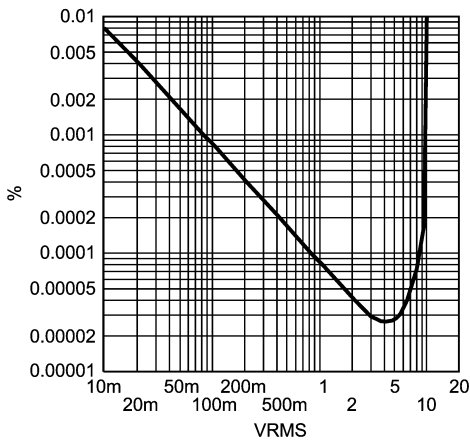

20157271

THD+N vs Output Voltage

$V_{CC} = 12V, V_{EE} = -12V$
 $R_L = 600\Omega$

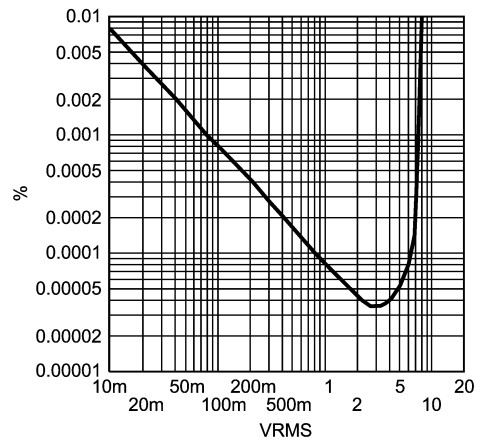

201572K2

Typical Performance Characteristics (Continued)

THD+N vs Output Voltage

$V_{CC} = 17V, V_{EE} = -17V$
 $R_L = 600\Omega$

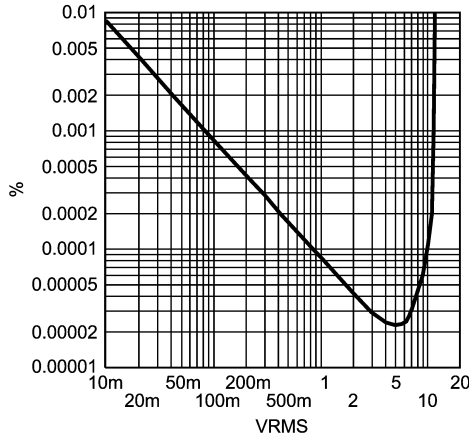

20157272

THD+N vs Output Voltage

$V_{CC} = 2.5V, V_{EE} = -2.5V$
 $R_L = 600\Omega$

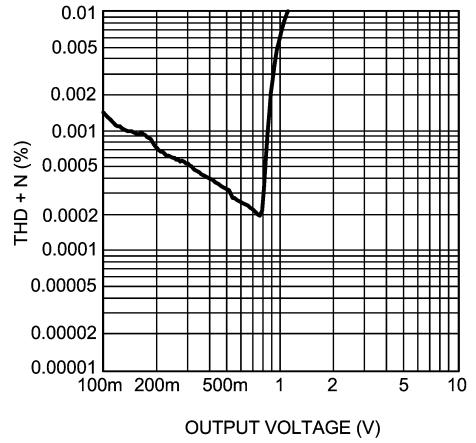

20157216

THD+N vs Output Voltage

$V_{CC} = 15V, V_{EE} = -15V$
 $R_L = 10k\Omega$

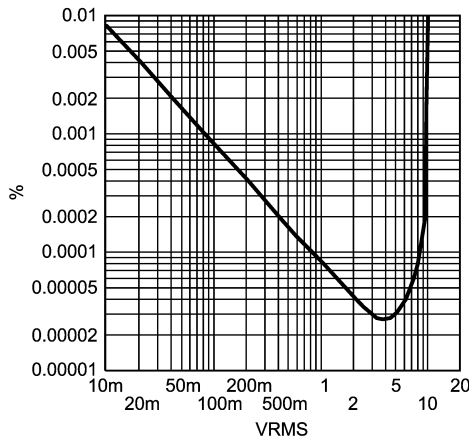

20157279

THD+N vs Output Voltage

$V_{CC} = 12V, V_{EE} = -12V$
 $R_L = 10k\Omega$

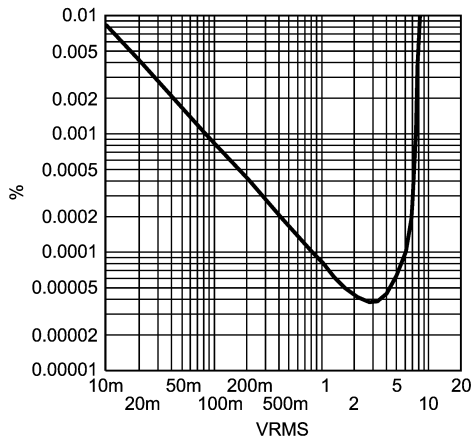

20157278

THD+N vs Output Voltage

$V_{CC} = 17V, V_{EE} = -17V$
 $R_L = 10k\Omega$

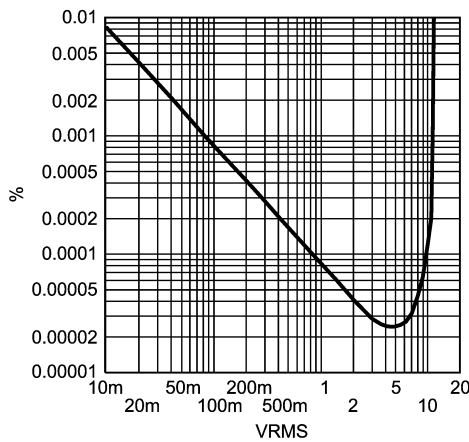

20157280

THD+N vs Output Voltage

$V_{CC} = 2.5V, V_{EE} = -2.5V$
 $R_L = 10k\Omega$

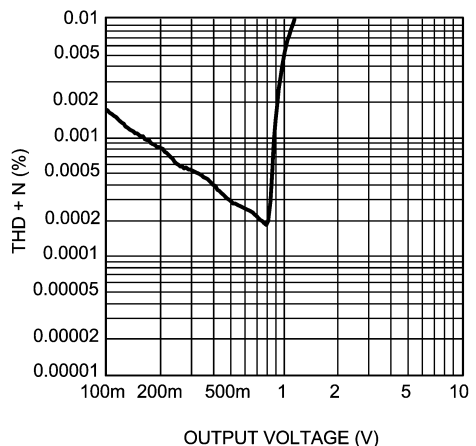

20157215

Typical Performance Characteristics (Continued)

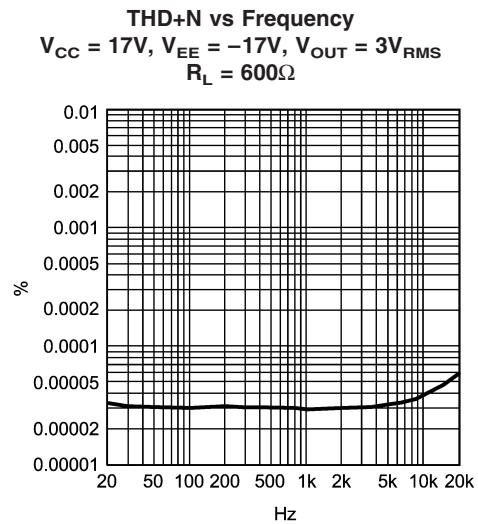
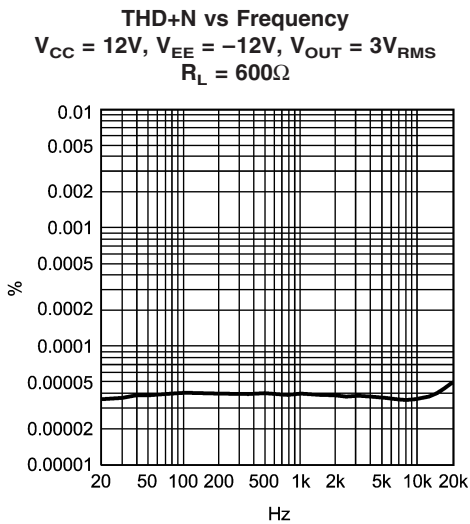
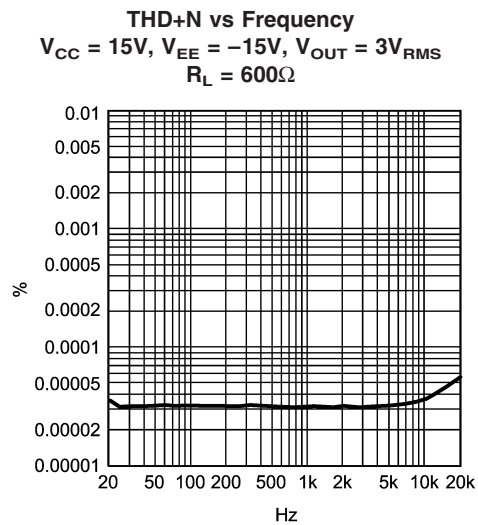
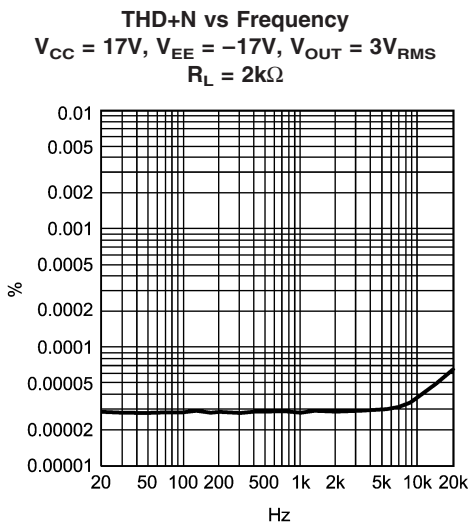
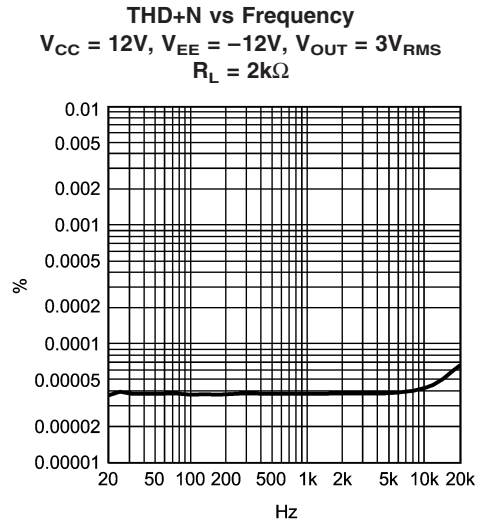
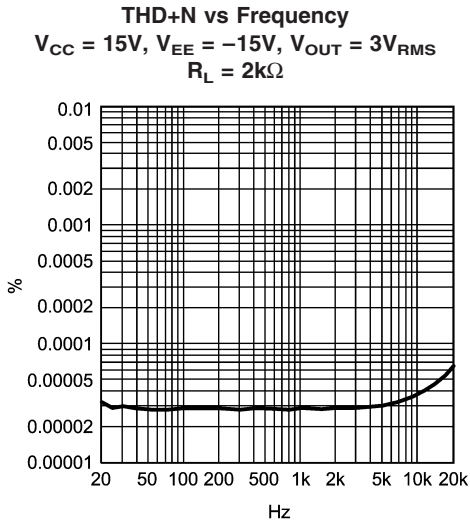

Typical Performance Characteristics (Continued)

THD+N vs Frequency
 $V_{CC} = 15V, V_{EE} = -15V, V_{OUT} = 3V_{RMS}$
 $R_L = 10k\Omega$

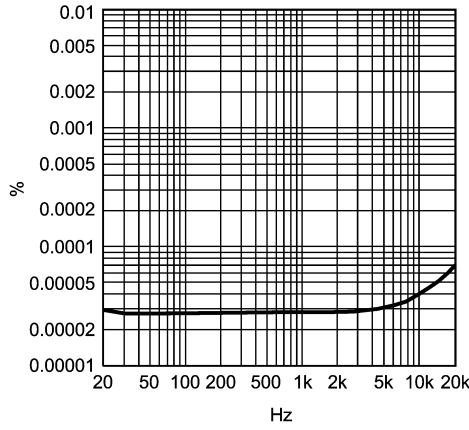

20157267

THD+N vs Frequency
 $V_{CC} = 12V, V_{EE} = -12V, V_{OUT} = 3V_{RMS}$
 $R_L = 10k\Omega$

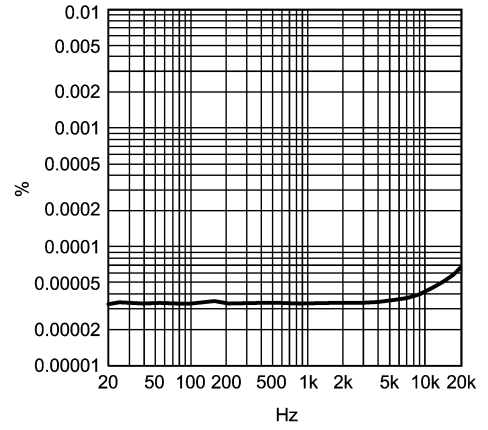

20157266

THD+N vs Frequency
 $V_{CC} = 17V, V_{EE} = -17V, V_{OUT} = 3V_{RMS}$
 $R_L = 10k\Omega$

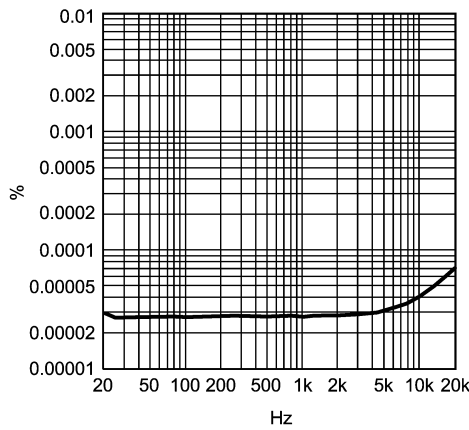

20157268

IMD vs Output Voltage
 $V_{CC} = 15V, V_{EE} = -15V$
 $R_L = 2k\Omega$

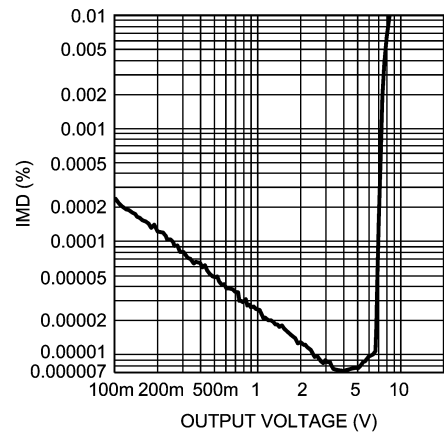

201572E6

IMD vs Output Voltage
 $V_{CC} = 12V, V_{EE} = -12V$
 $R_L = 2k\Omega$

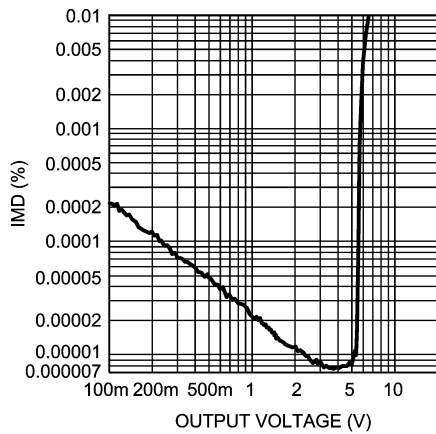

201572E5

IMD vs Output Voltage
 $V_{CC} = 2.5V, V_{EE} = -2.5V$
 $R_L = 2k\Omega$

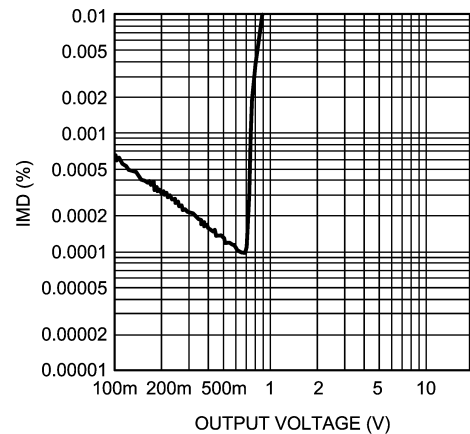

201572E4

Typical Performance Characteristics (Continued)

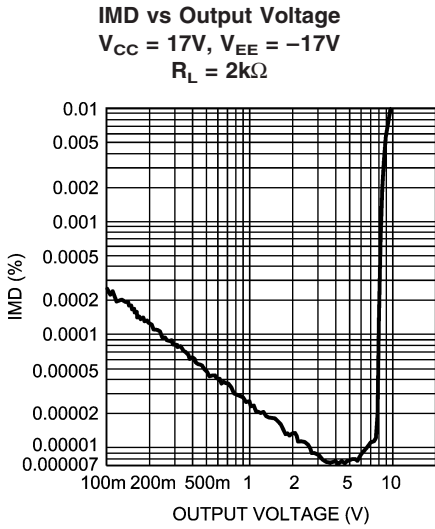

201572E7

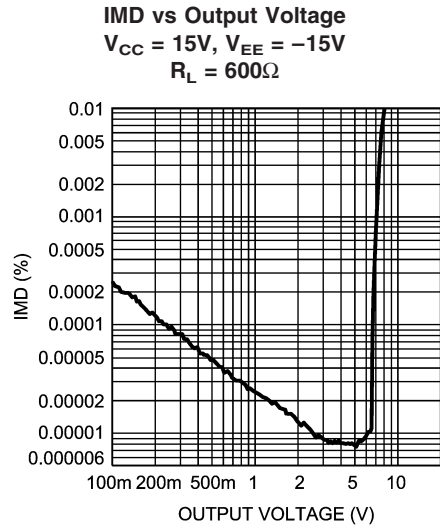

201572E2

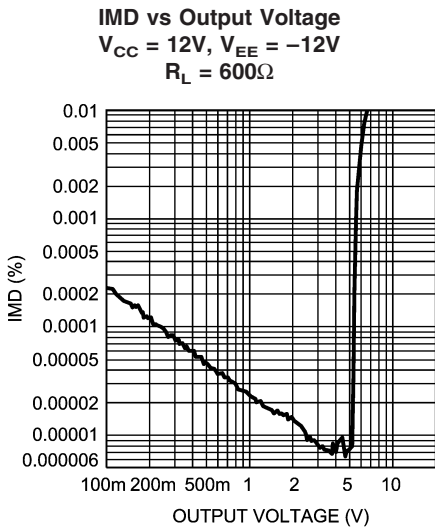

201572E0

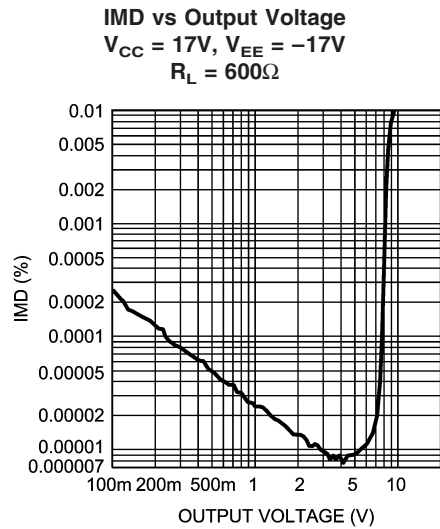

201572E3

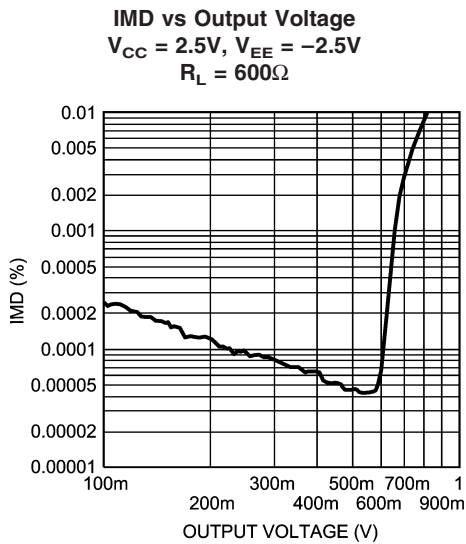

201572E1

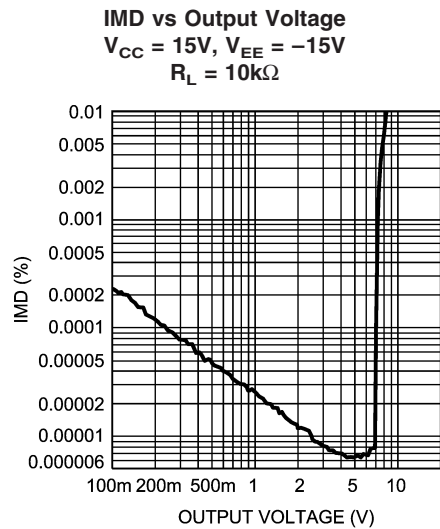

201572F1

Typical Performance Characteristics (Continued)

IMD vs Output Voltage

$V_{CC} = 12V, V_{EE} = -12V$
 $R_L = 10k\Omega$

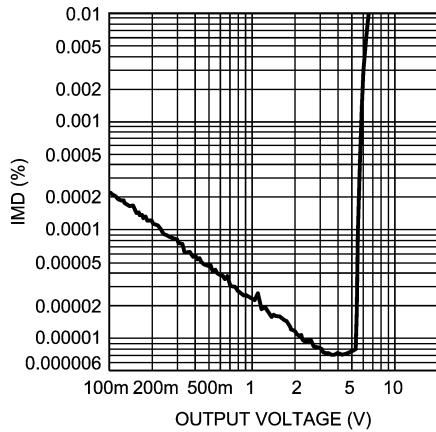

201572F0

IMD vs Output Voltage

$V_{CC} = 17V, V_{EE} = -17V$
 $R_L = 10k\Omega$

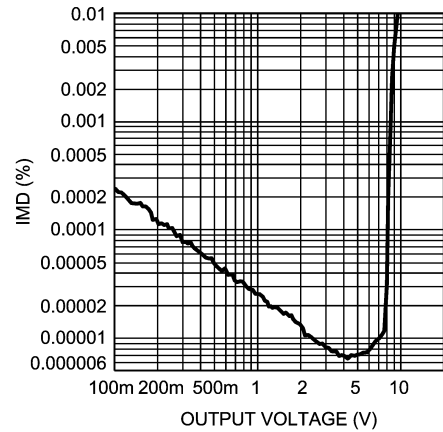

201572F2

IMD vs Output Voltage

$V_{CC} = 2.5V, V_{EE} = -2.5V$
 $R_L = 10k\Omega$

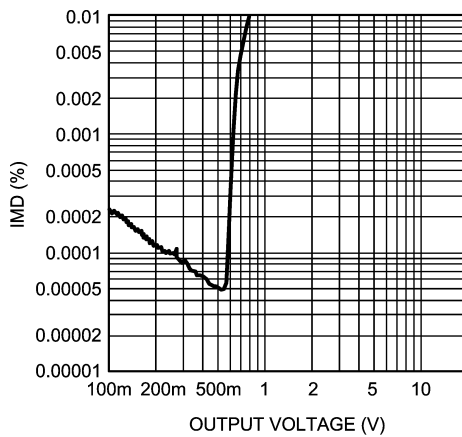

201572E9

Voltage Noise Density vs Frequency

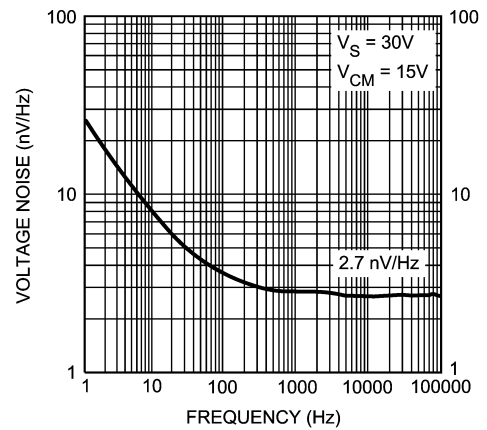

201572H6

Current Noise Density vs Frequency

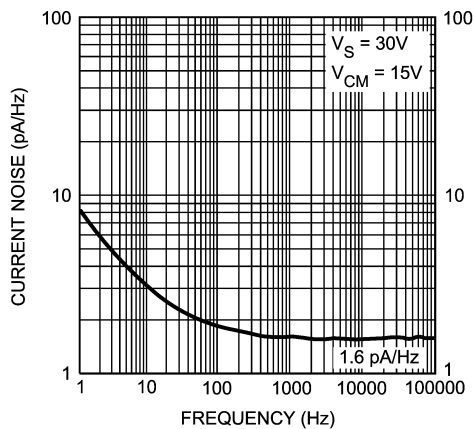

201572H7

Crosstalk vs Frequency

$V_{CC} = 15V, V_{EE} = -15V, V_{OUT} = 3V_{RMS}$
 $A_v = 0dB, R_L = 2k\Omega$

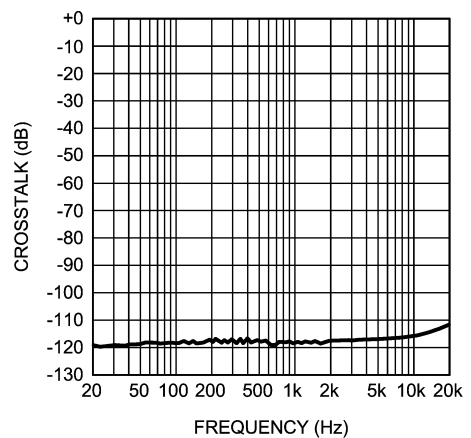

201572C8

Typical Performance Characteristics (Continued)

Crosstalk vs Frequency
 $V_{CC} = 15V, V_{EE} = -15V, V_{OUT} = 10V_{RMS}$
 $A_V = 0dB, R_L = 2k\Omega$

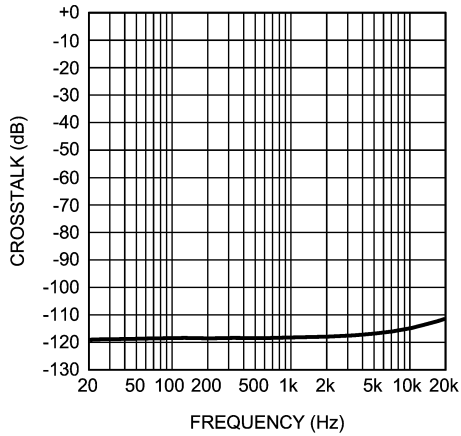

201572C9

Crosstalk vs Frequency
 $V_{CC} = 12V, V_{EE} = -12V, V_{OUT} = 3V_{RMS}$
 $A_V = 0dB, R_L = 2k\Omega$

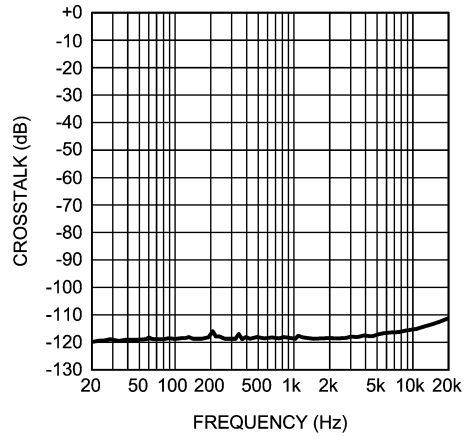

201572C6

Crosstalk vs Frequency
 $V_{CC} = 12V, V_{EE} = -12V, V_{OUT} = 10V_{RMS}$
 $A_V = 0dB, R_L = 2k\Omega$

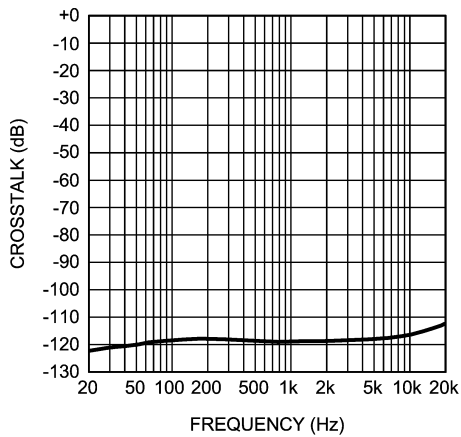

201572C7

Crosstalk vs Frequency
 $V_{CC} = 17V, V_{EE} = -17V, V_{OUT} = 3V_{RMS}$
 $A_V = 0dB, R_L = 2k\Omega$

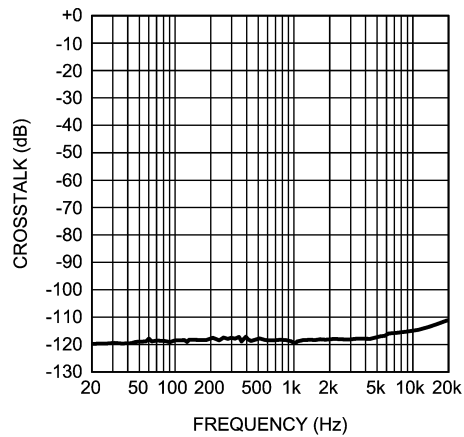

201572D0

Crosstalk vs Frequency
 $V_{CC} = 17V, V_{EE} = -17V, V_{OUT} = 10V_{RMS}$
 $A_V = 0dB, R_L = 2k\Omega$

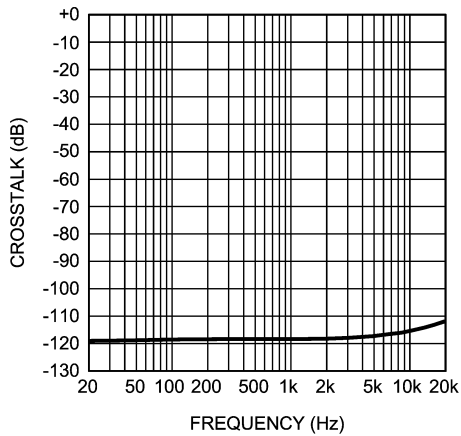

201572D1

Crosstalk vs Frequency
 $V_{CC} = 2.5V, V_{EE} = -2.5V, V_{OUT} = 1V_{RMS}$
 $A_V = 0dB, R_L = 2k\Omega$

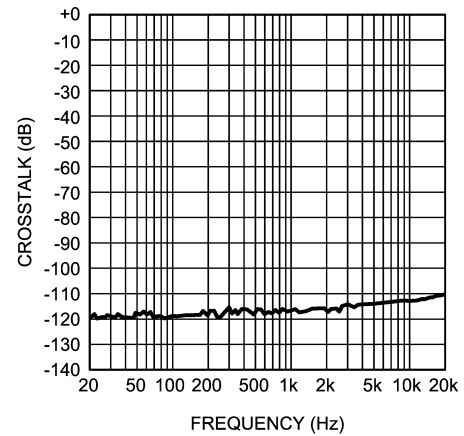

201572C4

Typical Performance Characteristics (Continued)

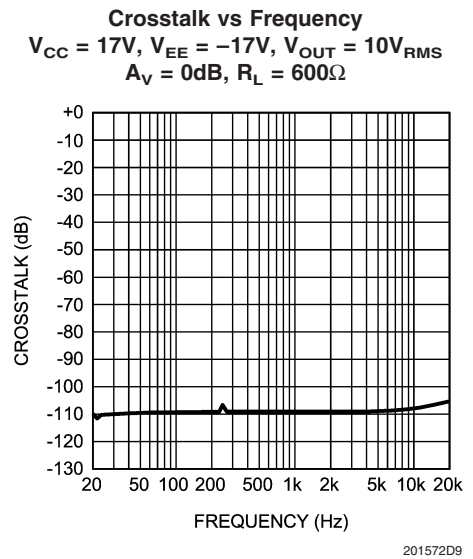
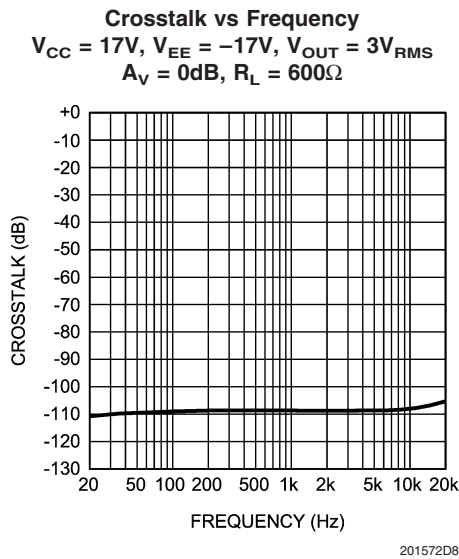
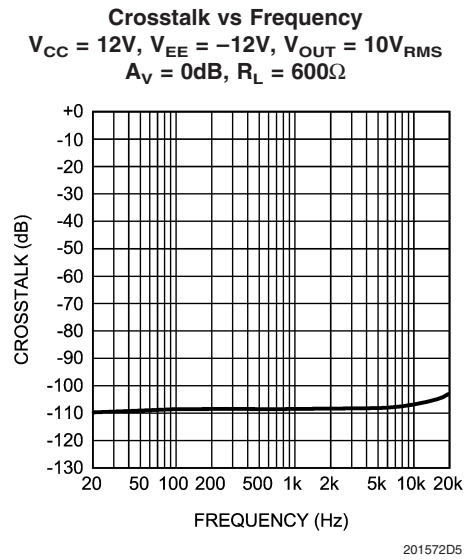
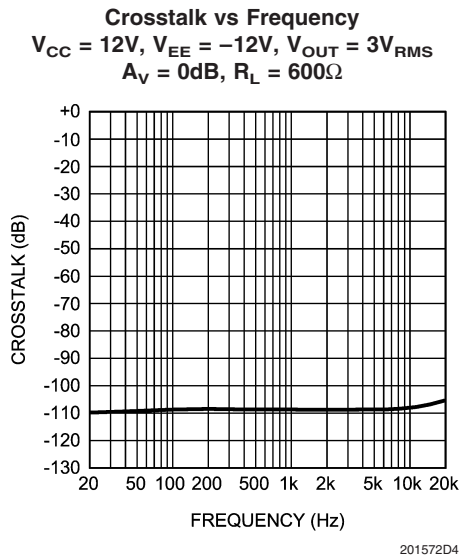
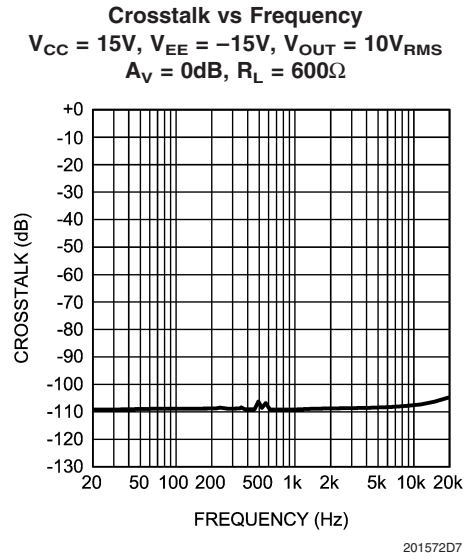
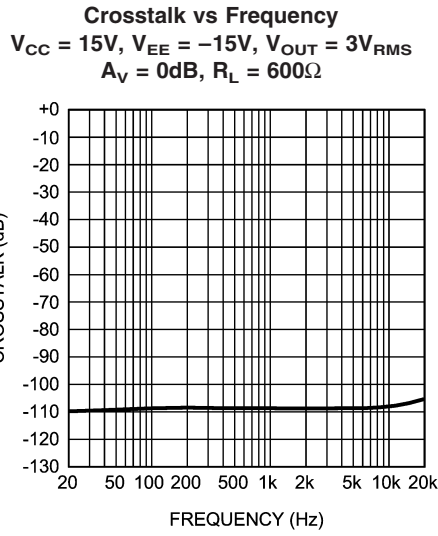

Typical Performance Characteristics (Continued)

Crosstalk vs Frequency
 $V_{CC} = 2.5V$, $V_{EE} = -2.5V$, $V_{OUT} = 1V_{RMS}$
 $A_V = 0dB$, $R_L = 600\Omega$

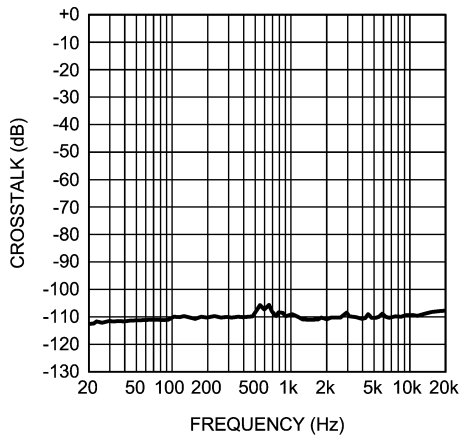

201572D2

Crosstalk vs Frequency
 $V_{CC} = 15V$, $V_{EE} = -15V$, $V_{OUT} = 3V_{RMS}$
 $A_V = 0dB$, $R_L = 10k\Omega$

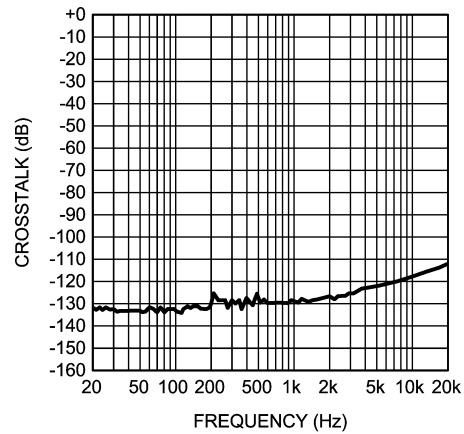

201572C0

Crosstalk vs Frequency
 $V_{CC} = 15V$, $V_{EE} = -15V$, $V_{OUT} = 10V_{RMS}$
 $A_V = 0dB$, $R_L = 10k\Omega$

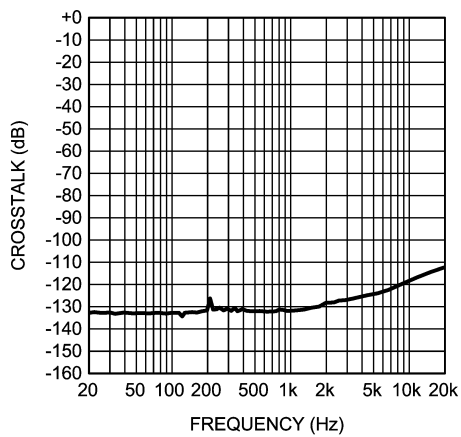

201572C1

Crosstalk vs Frequency
 $V_{CC} = 12V$, $V_{EE} = -12V$, $V_{OUT} = 3V_{RMS}$
 $A_V = 0dB$, $R_L = 10k\Omega$

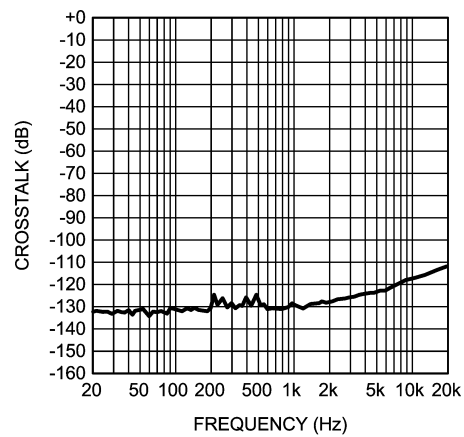

201572B8

Crosstalk vs Frequency
 $V_{CC} = 12V$, $V_{EE} = -12V$, $V_{OUT} = 10V_{RMS}$
 $A_V = 0dB$, $R_L = 10k\Omega$

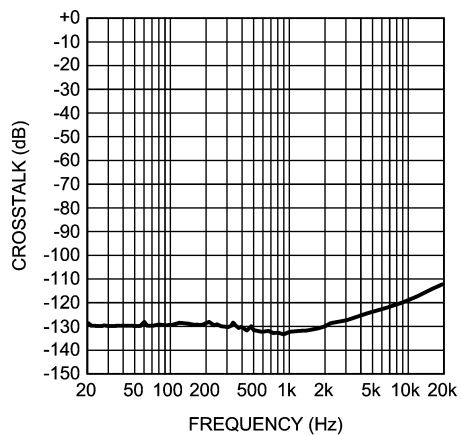

201572B9

Crosstalk vs Frequency
 $V_{CC} = 17V$, $V_{EE} = -17V$, $V_{OUT} = 3V_{RMS}$
 $A_V = 0dB$, $R_L = 10k\Omega$

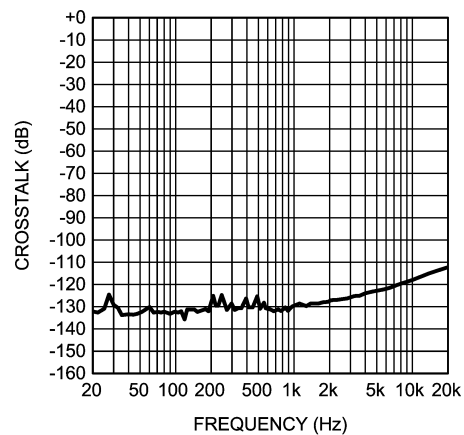

201572C2

Typical Performance Characteristics (Continued)

Crosstalk vs Frequency
 $V_{CC} = 17V, V_{EE} = -17V, V_{OUT} = 10V_{RMS}$
 $A_V = 0dB, R_L = 10k\Omega$

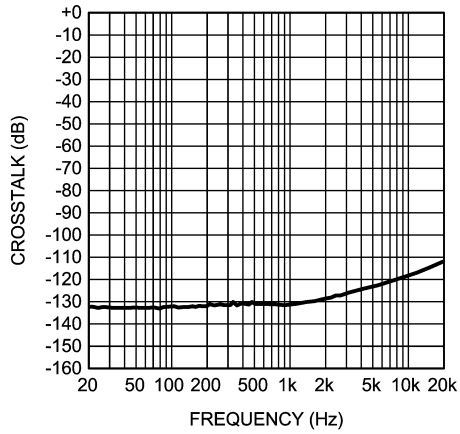

201572C3

Crosstalk vs Frequency
 $V_{CC} = 2.5V, V_{EE} = -2.5V, V_{OUT} = 1V_{RMS}$
 $A_V = 0dB, R_L = 10k\Omega$

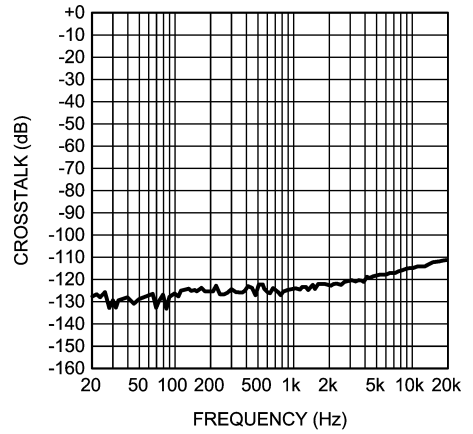

201572B6

PSRR+ vs Frequency
 $V_{CC} = 15V, V_{EE} = -15V$
 $R_L = 2k\Omega, V_{RIPPLE} = 200mVpp$

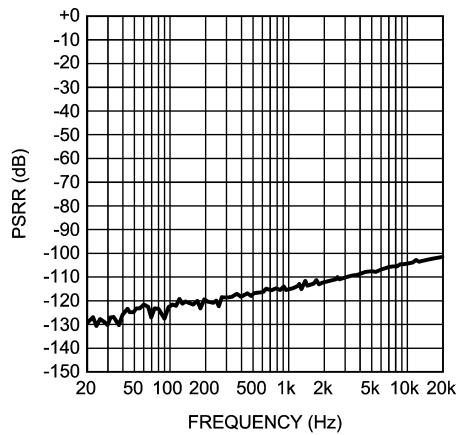

201572B0

PSRR- vs Frequency
 $V_{CC} = 15V, V_{EE} = -15V$
 $R_L = 2k\Omega, V_{RIPPLE} = 200mVpp$

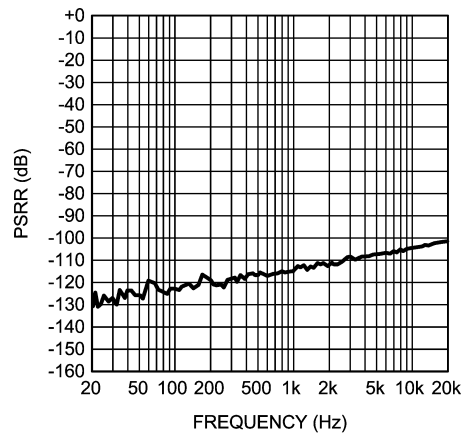

201572B4

PSRR+ vs Frequency
 $V_{CC} = 12V, V_{EE} = -12V$
 $R_L = 2k\Omega, V_{RIPPLE} = 200mVpp$

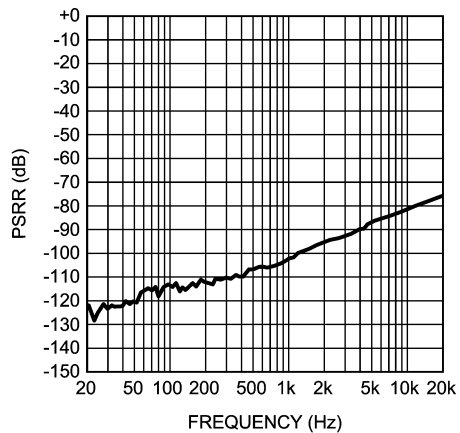

201572A9

PSRR- vs Frequency
 $V_{CC} = 12V, V_{EE} = -12V$
 $R_L = 2k\Omega, V_{RIPPLE} = 200mVpp$

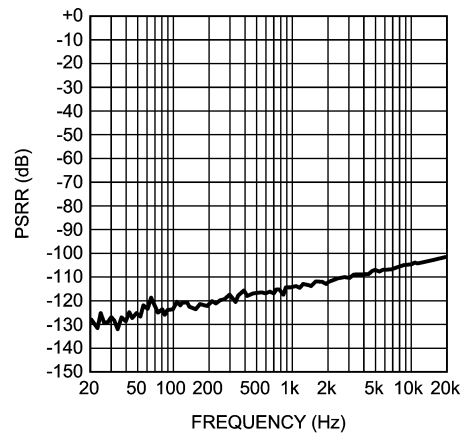

201572B3

Typical Performance Characteristics (Continued)

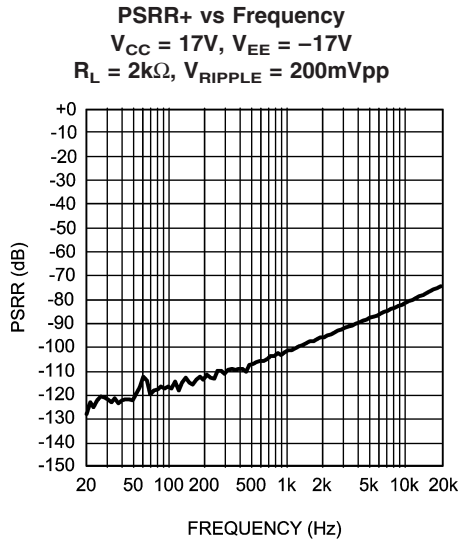

201572J3

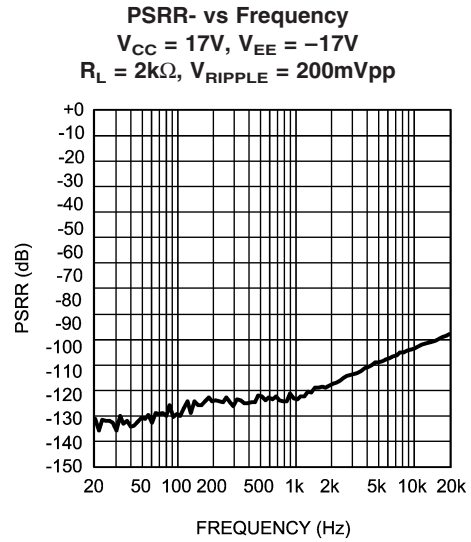

201572J2

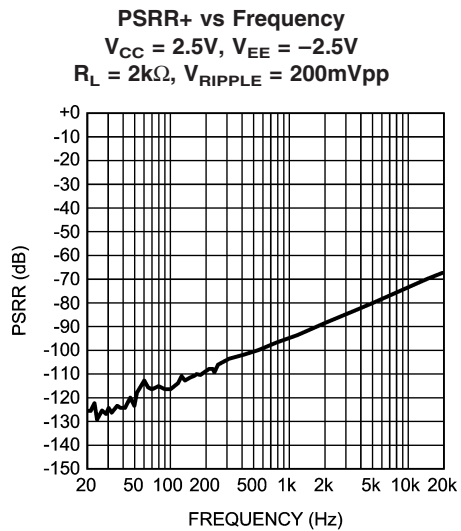

201572A8

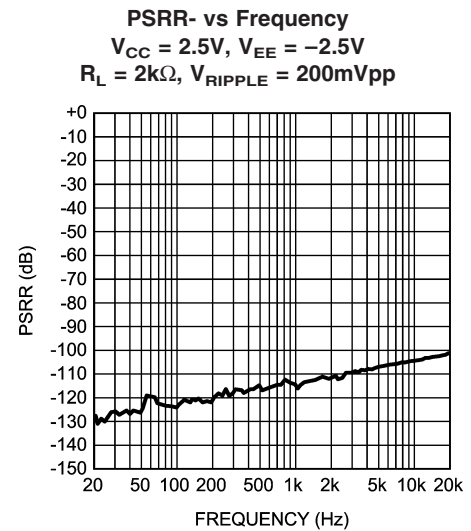

201572B2

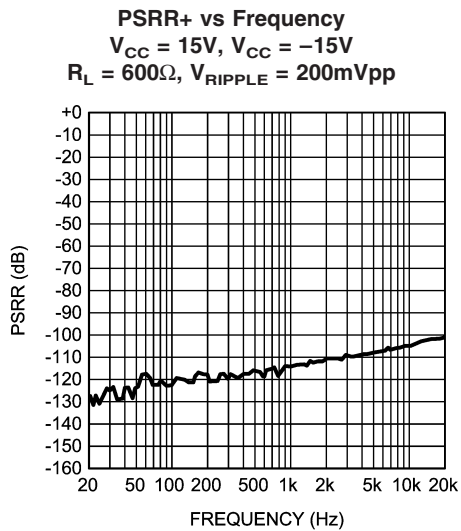

201572A1

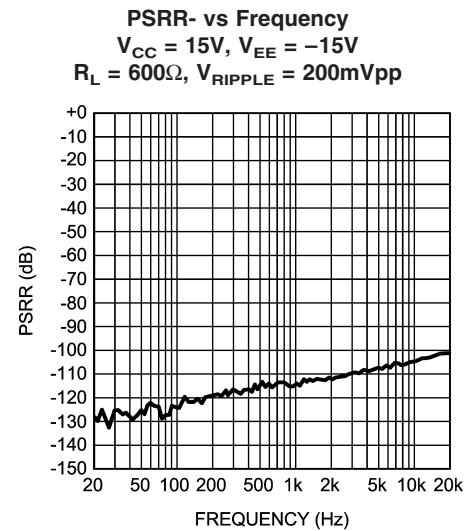

201572A6

Typical Performance Characteristics (Continued)

PSRR+ vs Frequency
 $V_{CC} = 12V, V_{CC} = -12V$
 $R_L = 600\Omega, V_{RIPPLE} = 200mVpp$

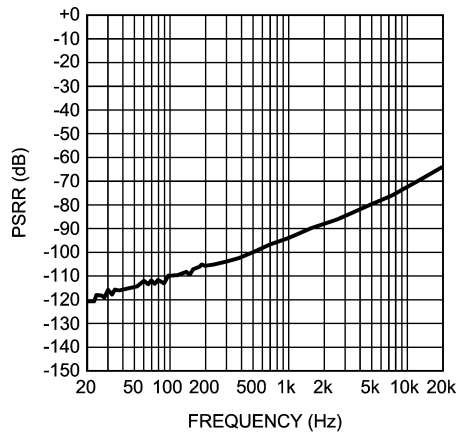

201572A0

PSRR- vs Frequency
 $V_{CC} = 12V, V_{EE} = -12V$
 $R_L = 600\Omega, V_{RIPPLE} = 200mVpp$

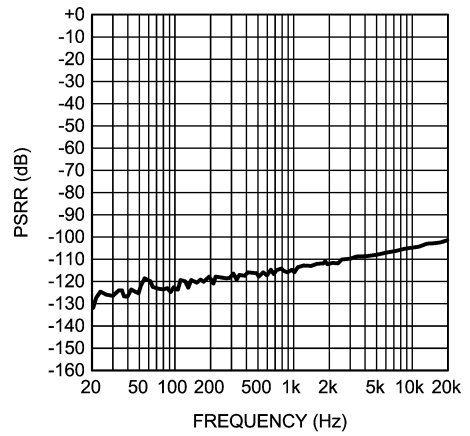

201572A5

PSRR+ vs Frequency
 $V_{CC} = 17V, V_{CC} = -17V$
 $R_L = 600\Omega, V_{RIPPLE} = 200mVpp$

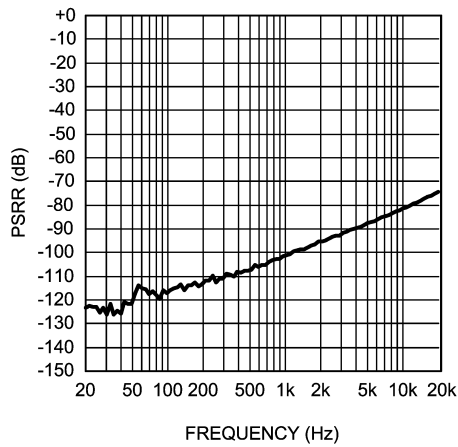

201572J4

PSRR- vs Frequency
 $V_{CC} = 17V, V_{CC} = -17V$
 $R_L = 600\Omega, V_{RIPPLE} = 200mVpp$

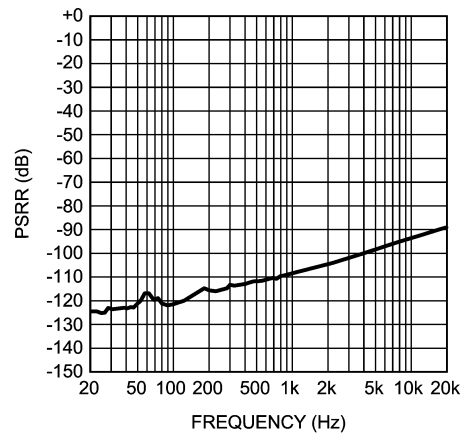

201572A3

PSRR+ vs Frequency
 $V_{CC} = 2.5V, V_{CC} = -2.5V$
 $R_L = 600\Omega, V_{RIPPLE} = 200mVpp$

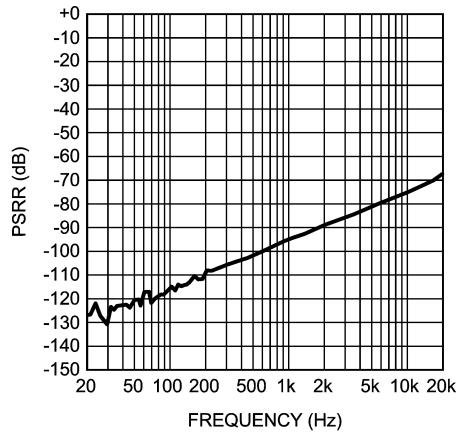

20157299

PSRR- vs Frequency
 $V_{CC} = 2.5V, V_{EE} = -2.5V$
 $R_L = 600\Omega, V_{RIPPLE} = 200mVpp$

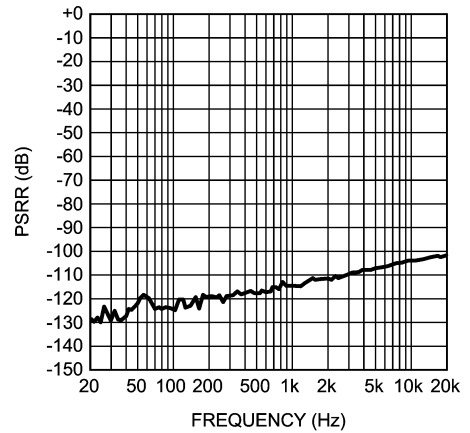

201572A4

Typical Performance Characteristics (Continued)

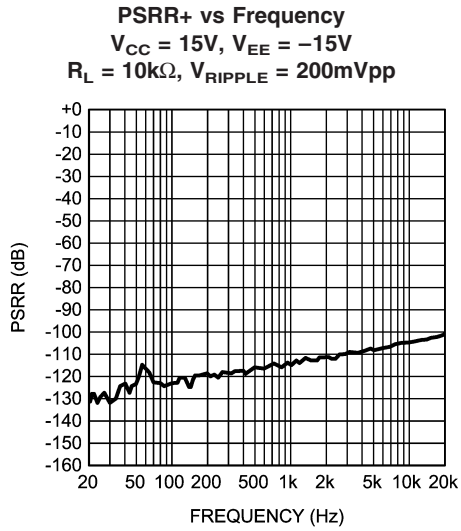

20157293

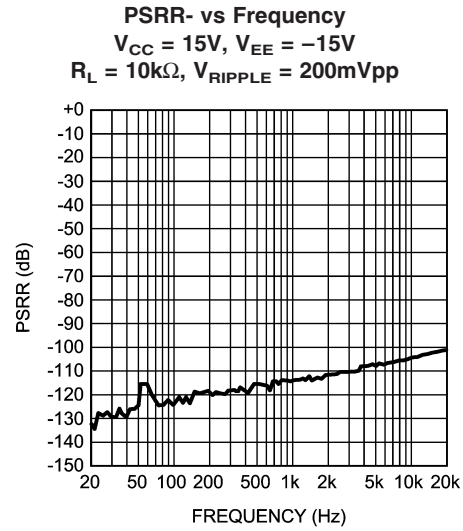

20157297

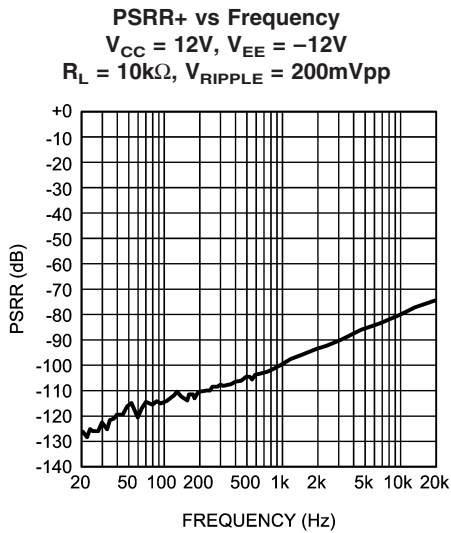

20157292

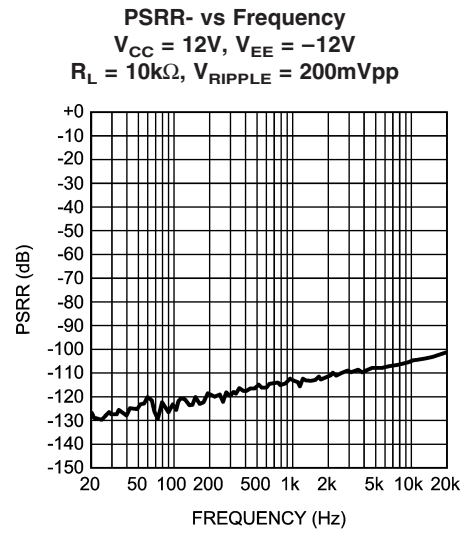

20157296

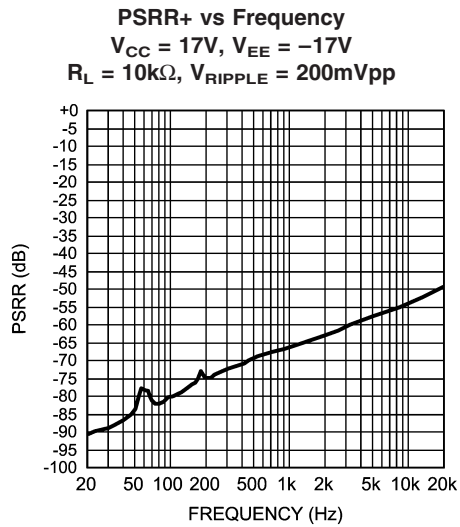

20157294

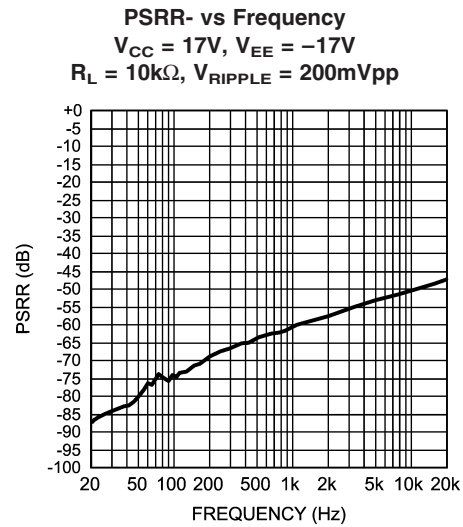

20157298

Typical Performance Characteristics (Continued)

PSRR+ vs Frequency
 $V_{CC} = 2.5V, V_{EE} = -2.5V$
 $R_L = 10k\Omega, V_{RIPPLE} = 200mV_{pp}$

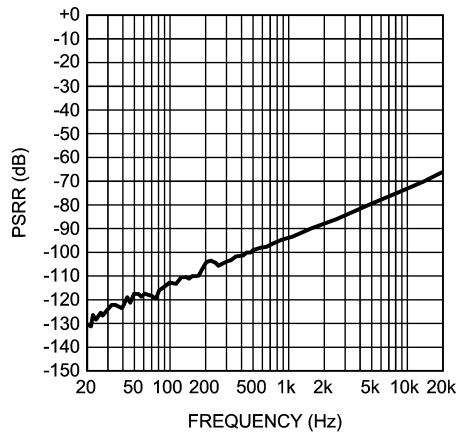

20157291

PSRR- vs Frequency
 $V_{CC} = 2.5V, V_{EE} = -2.5V$
 $R_L = 10k\Omega, V_{RIPPLE} = 200mV_{pp}$

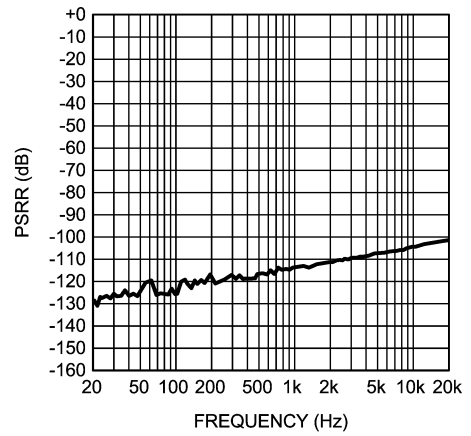

20157295

CMRR vs Frequency
 $V_{CC} = 15V, V_{EE} = -15V$
 $R_L = 2k\Omega$

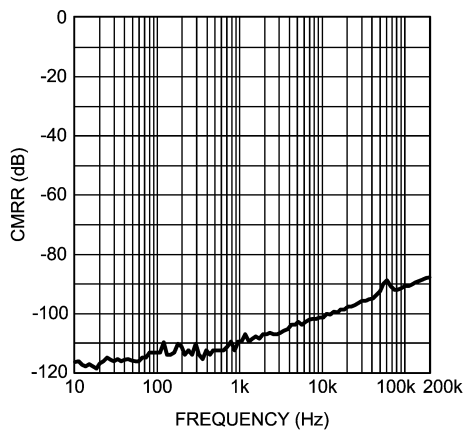

201572G0

CMRR vs Frequency
 $V_{CC} = 12V, V_{EE} = -12V$
 $R_L = 2k\Omega$

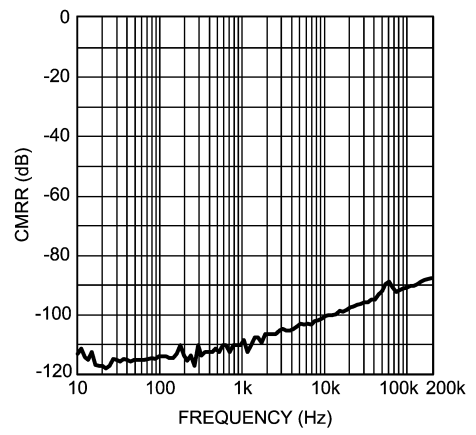

201572F7

CMRR vs Frequency
 $V_{CC} = 17V, V_{EE} = -17V$
 $R_L = 2k\Omega$

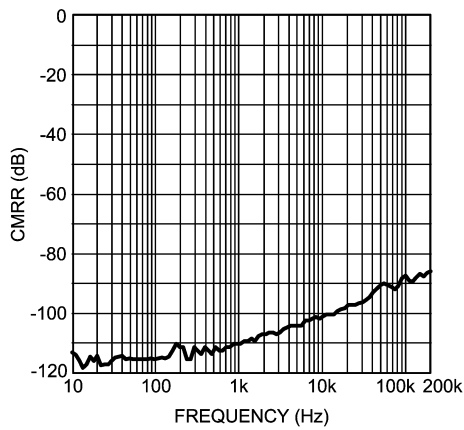

201572G3

CMRR vs Frequency
 $V_{CC} = 2.5V, V_{EE} = -2.5V$
 $R_L = 2k\Omega$

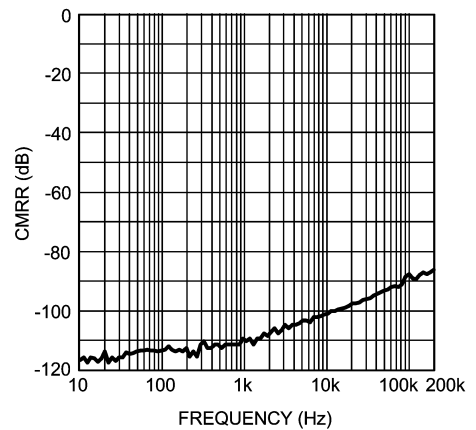

201572F4

Typical Performance Characteristics (Continued)

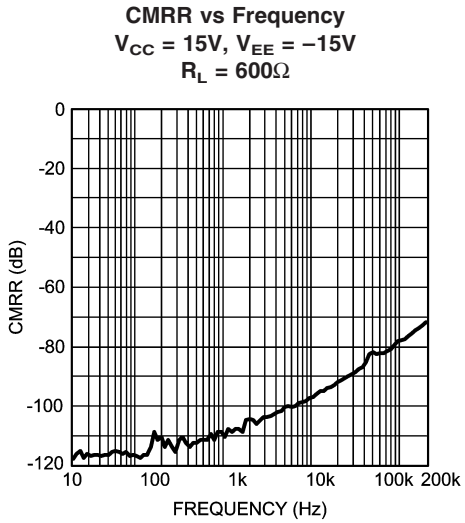

201572G2

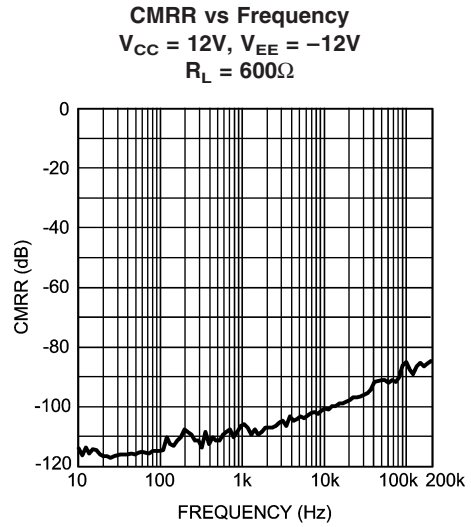

201572F9

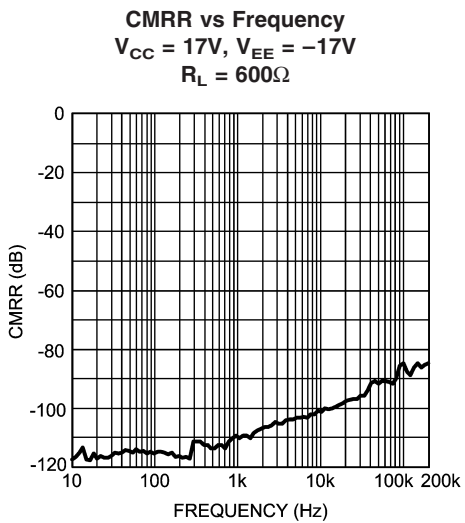

201572G5

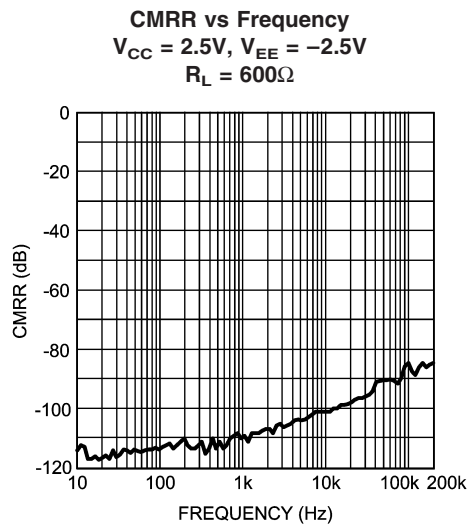

201572F6

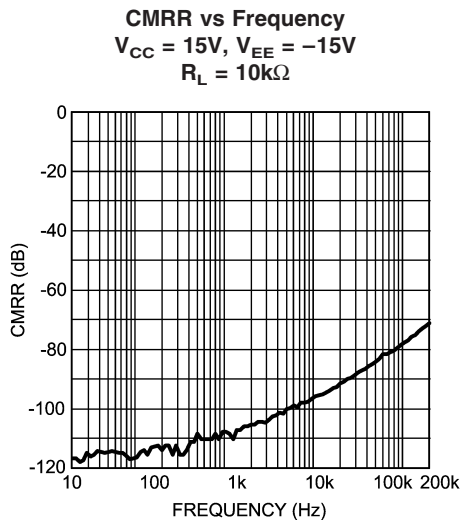

201572G1

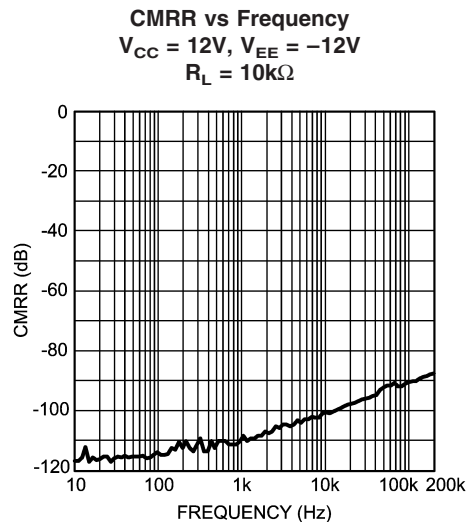

201572F8

Typical Performance Characteristics (Continued)

CMRR vs Frequency
 $V_{CC} = 17V, V_{EE} = -17V$
 $R_L = 10k\Omega$

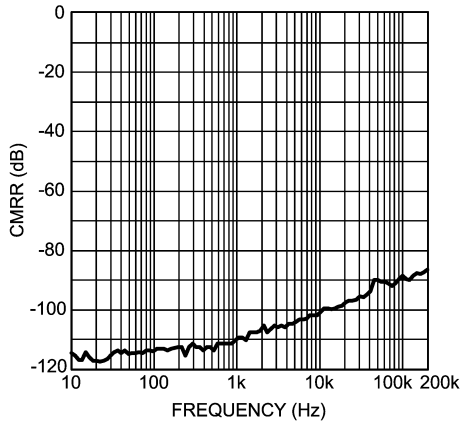

201572G4

CMRR vs Frequency
 $V_{CC} = 2.5V, V_{EE} = -2.5V$
 $R_L = 10k\Omega$

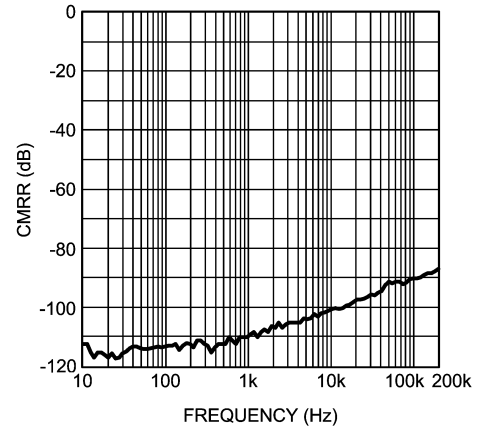

201572F5

Output Voltage vs Load Resistance
 $V_{DD} = 15V, V_{EE} = -15V$
 $THD+N = 1\%$

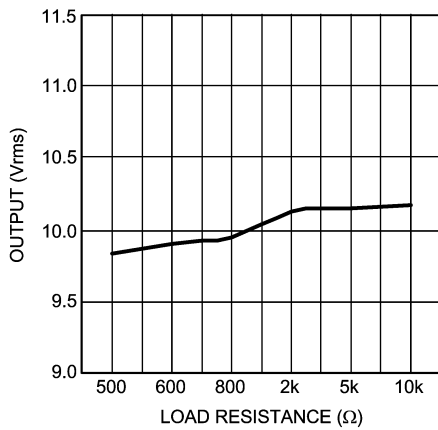

201572H1

Output Voltage vs Load Resistance
 $V_{DD} = 12V, V_{EE} = -12V$
 $THD+N = 1\%$

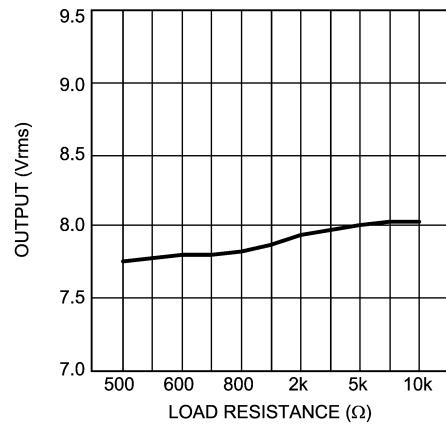

201572H0

Output Voltage vs Load Resistance
 $V_{DD} = 17V, V_{EE} = -17V$
 $THD+N = 1\%$

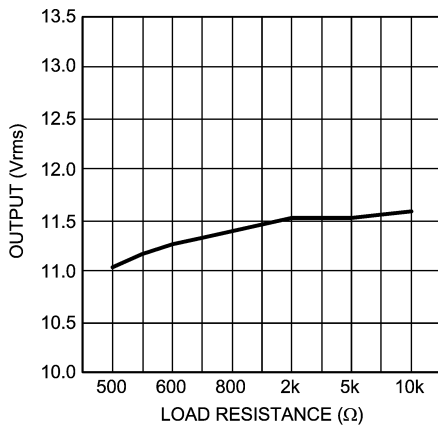

201572H2

Output Voltage vs Load Resistance
 $V_{DD} = 2.5V, V_{EE} = -2.5V$
 $THD+N = 1\%$

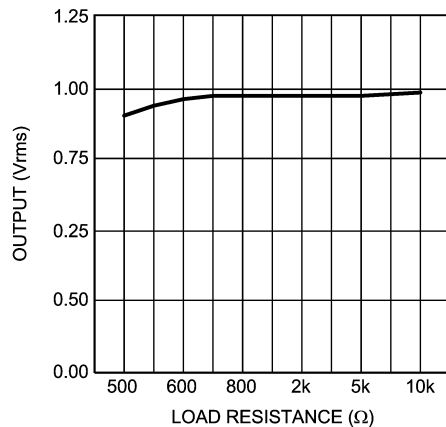

201572G9

Typical Performance Characteristics (Continued)

Output Voltage vs Supply Voltage
 $R_L = 2k\Omega$, THD+N = 1%

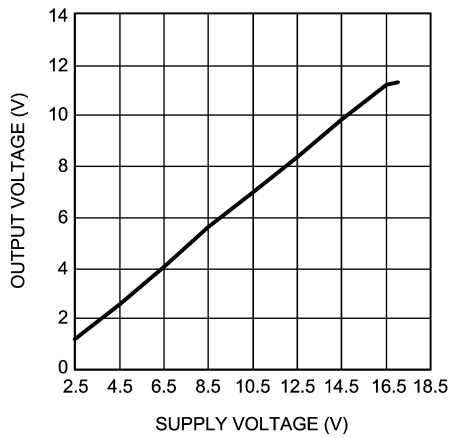

201572J9

Output Voltage vs Supply Voltage
 $R_L = 600\Omega$, THD+N = 1%

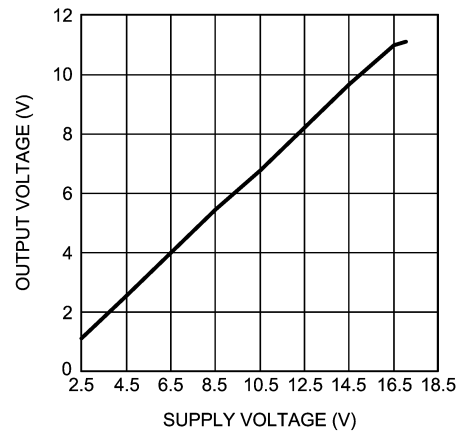

201572J8

Output Voltage vs Supply Voltage
 $R_L = 10k\Omega$, THD+N = 1%

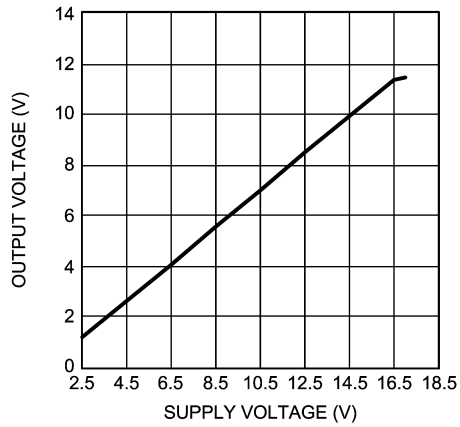

201572K0

Supply Current vs Supply Voltage
 $R_L = 2k\Omega$

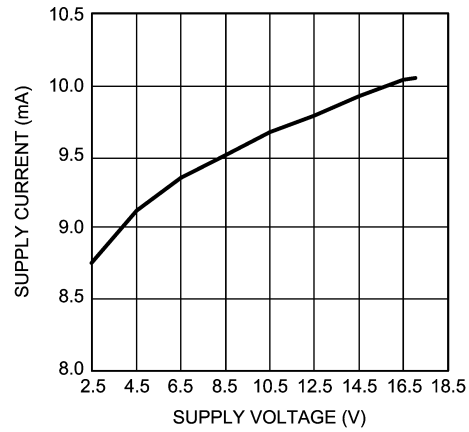

201572J6

Supply Current vs Supply Voltage
 $R_L = 600\Omega$

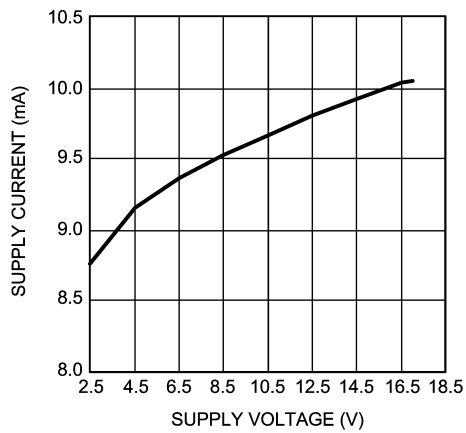

201572J5

Supply Current vs Supply Voltage
 $R_L = 10k\Omega$

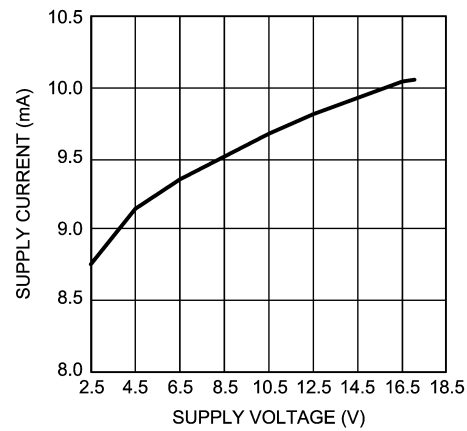

201572J7

Typical Performance Characteristics (Continued)

Full Power Bandwidth vs Frequency

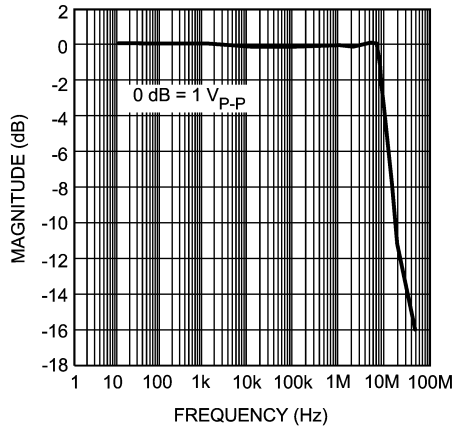

Gain Phase vs Frequency

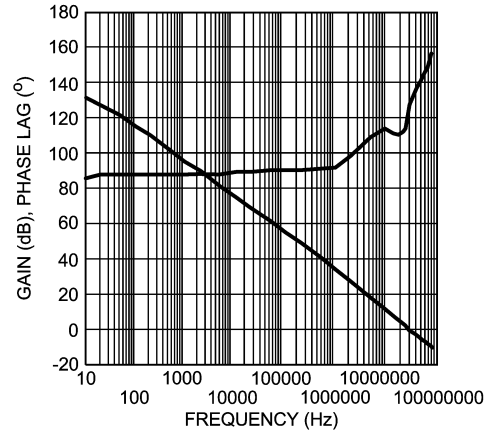

Small-Signal Transient Response
 $A_V = 1$, $C_L = 10\text{pF}$

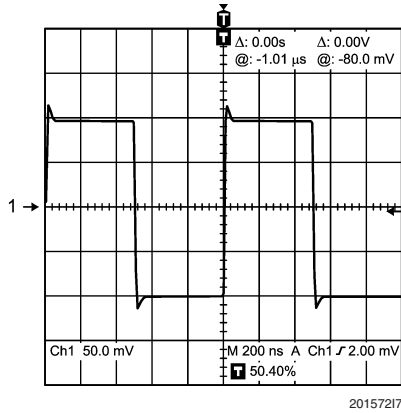

Small-Signal Transient Response
 $A_V = 1$, $C_L = 100\text{pF}$

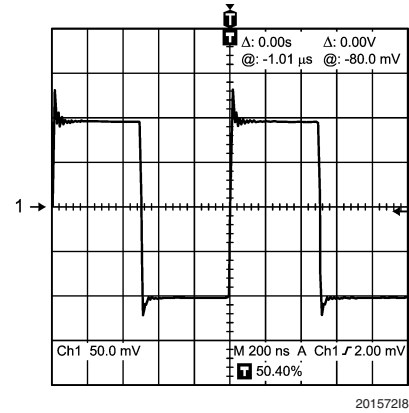

Application Information

DISTORTION MEASUREMENTS

The vanishingly low residual distortion produced by LM4562 is below the capabilities of all commercially available equipment. This makes distortion measurements just slightly more difficult than simply connecting a distortion meter to the amplifier's inputs and outputs. The solution, however, is quite simple: an additional resistor. Adding this resistor extends the resolution of the distortion measurement equipment.

The LM4562's low residual distortion is an input referred internal error. As shown in Figure 1, adding the 10Ω resistor connected between the amplifier's inverting and non-inverting inputs changes the amplifier's noise gain. The re-

sult is that the error signal (distortion) is amplified by a factor of 101. Although the amplifier's closed-loop gain is unaltered, the feedback available to correct distortion errors is reduced by 101, which means that measurement resolution increases by 101. To ensure minimum effects on distortion measurements, keep the value of R1 low as shown in Figure 1.

This technique is verified by duplicating the measurements with high closed loop gain and/or making the measurements at high frequencies. Doing so produces distortion components that are within the measurement equipment's capabilities. This datasheet's THD+N and IMD values were generated using the above described circuit connected to an Audio Precision System Two Cascade.

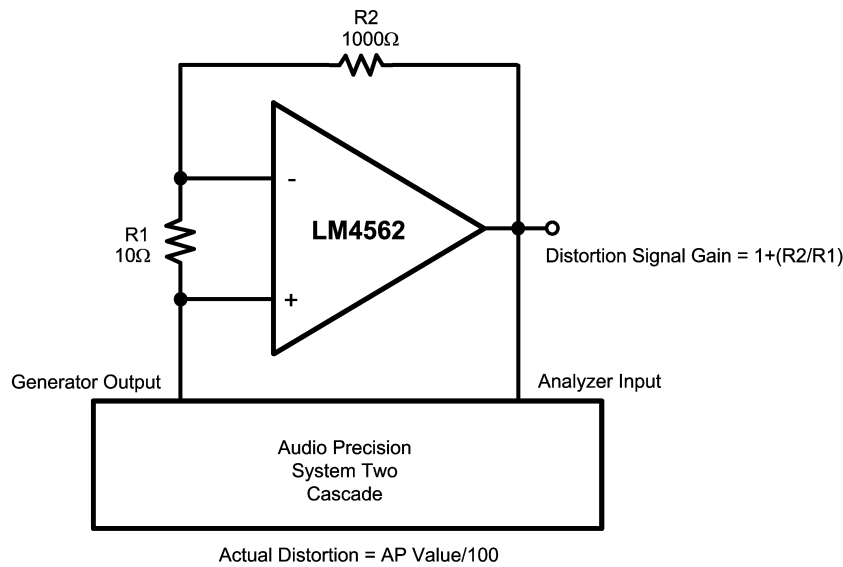

201572K4

FIGURE 1. THD+N and IMD Distortion Test Circuit

Application Information (Continued)

NOISE MEASUREMENT CIRCUIT

The LM4562 is a high speed op amp with excellent phase margin and stability. Capacitive loads up to 100pF will cause little change in the phase characteristics of the amplifiers and are therefore allowable.

Capacitive loads greater than 100pF must be isolated from the output. The most straightforward way to do this is to put a resistor in series with the output. This resistor will also prevent excess power dissipation if the output is accidentally shorted.

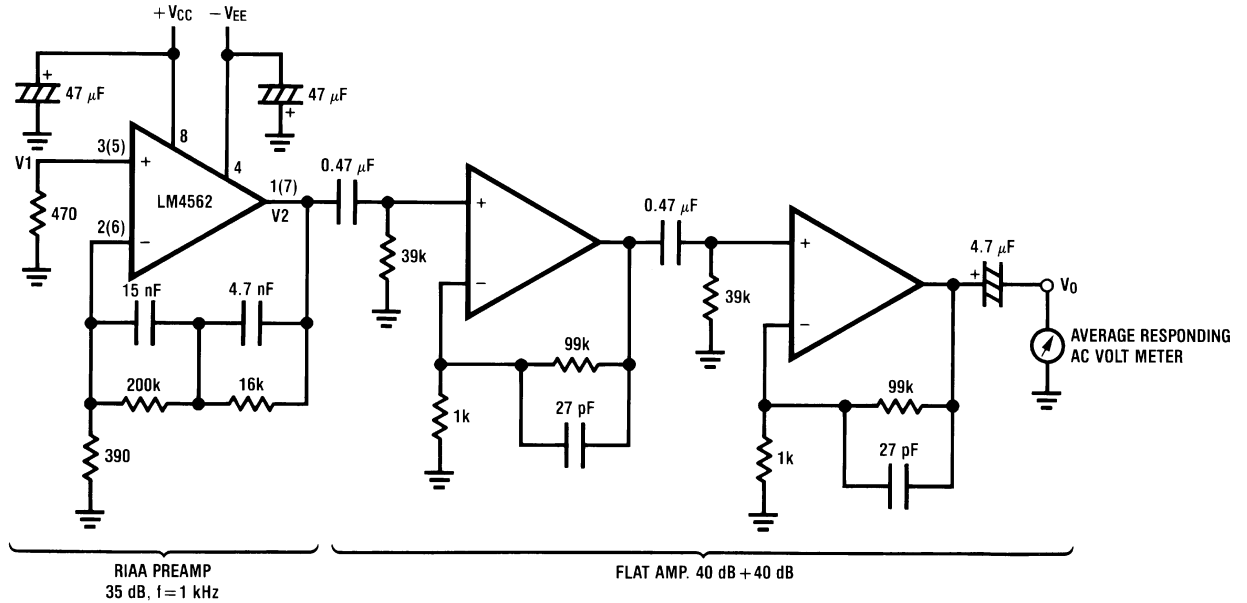

Complete shielding is required to prevent induced pick up from external sources. Always check with oscilloscope for power line noise.

20157227

Total Gain: 115 dB @ f = 1 kHz
Input Referred Noise Voltage: $e_n = V_0/560,000$ (V)

RIAA Preamp Voltage Gain, RIAA Deviation vs Frequency

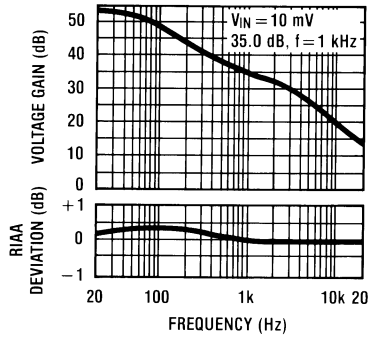

Flat Amp Voltage Gain vs Frequency

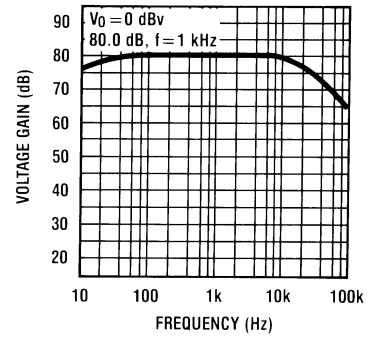

Application Information (Continued)

TYPICAL APPLICATIONS

NAB Preamp

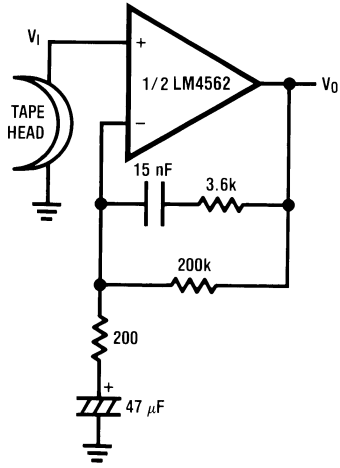

20157230

$A_V = 34.5$
 $F = 1 \text{ kHz}$
 $E_n = 0.38 \mu\text{V}$
 A Weighted

NAB Preamp Voltage Gain vs Frequency

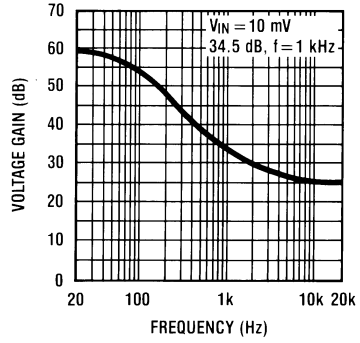

20157231

Balanced to Single Ended Converter

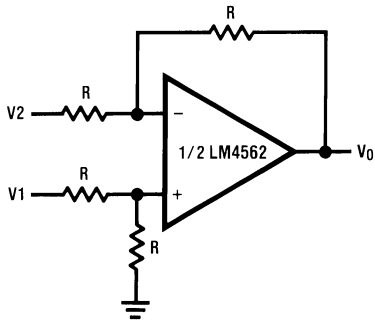

20157232

$$V_O = V_1 - V_2$$

Adder/Subtractor

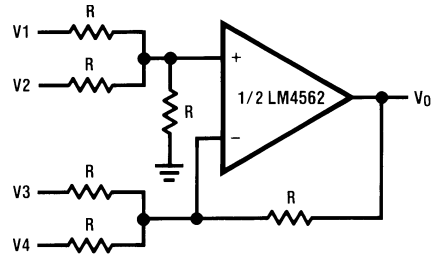

20157233

$$V_O = V_1 + V_2 - V_3 - V_4$$

Sine Wave Oscillator

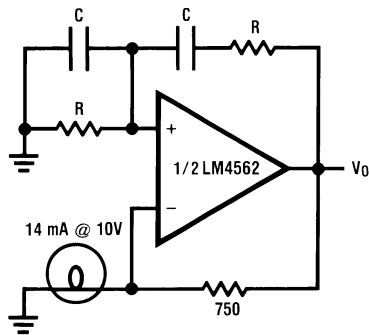

20157234

$$f_o = \frac{1}{2\pi RC}$$

Application Information (Continued)

Second Order High Pass Filter (Butterworth)

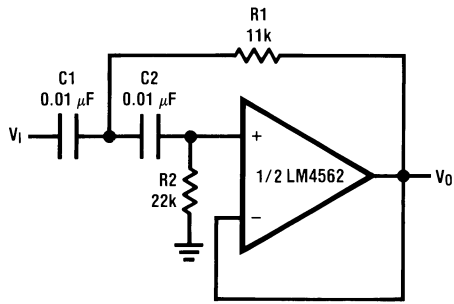

20157235

if $C1 = C2 = C$

$$R1 = \frac{\sqrt{2}}{2\omega_0 C}$$

$$R2 = 2 \cdot R1$$

Illustration is $f_0 = 1$ kHz

Second Order Low Pass Filter (Butterworth)

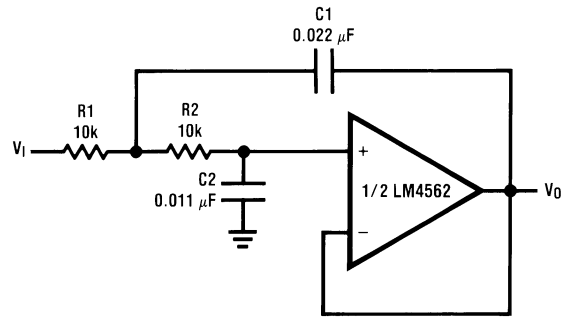

20157236

if $R1 = R2 = R$

$$C1 = \frac{\sqrt{2}}{\omega_0 R}$$

$$C2 = \frac{C1}{2}$$

Illustration is $f_0 = 1$ kHz

State Variable Filter

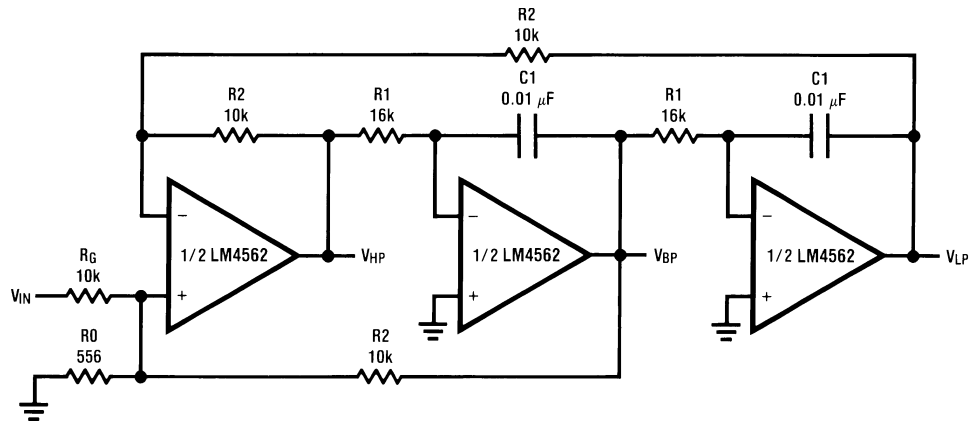

20157237

$$f_0 = \frac{1}{2\pi C1 R1}, Q = \frac{1}{2} \left(1 + \frac{R2}{R0} + \frac{R2}{RG} \right), A_{BP} = Q A_{LP} = Q A_{HP} = \frac{R2}{RG}$$

Illustration is $f_0 = 1$ kHz, $Q = 10$, $A_{BP} = 1$

Application Information (Continued)

AC/DC Converter

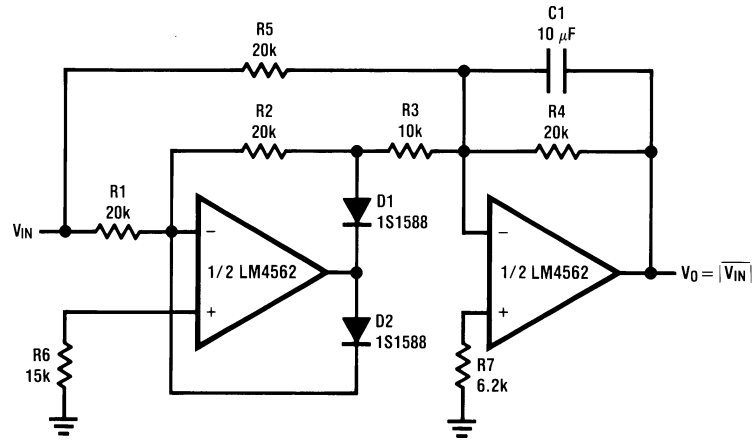

20157238

2 Channel Panning Circuit (Pan Pot)

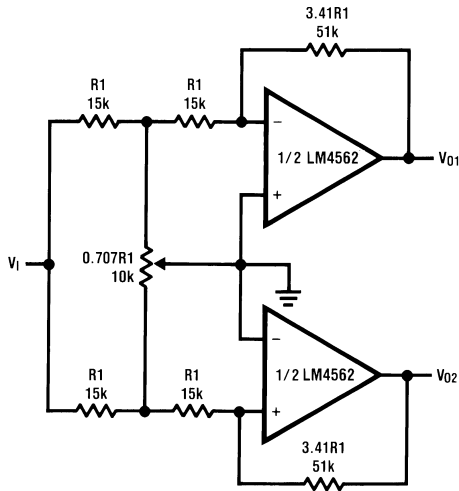

20157239

Line Driver

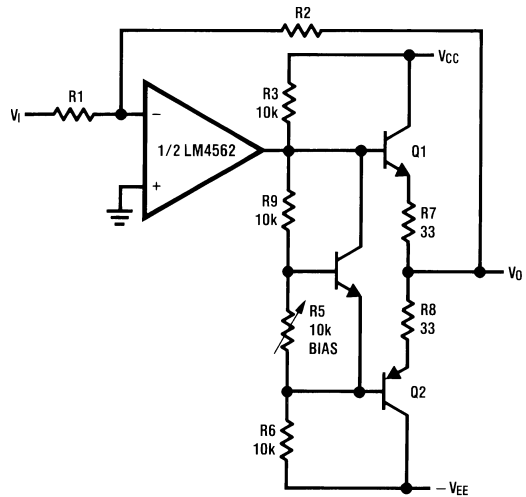

20157240

Application Information (Continued)

Tone Control

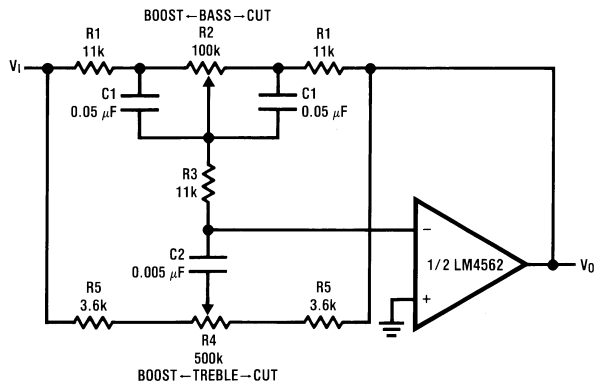

20157241

$$f_L = \frac{1}{2\pi R_2 C_1}, f_{LB} = \frac{1}{2\pi R_1 C_1}$$

$$f_H = \frac{1}{2\pi R_5 C_2}, f_{HB} = \frac{1}{2\pi (R_1 + R_5 + 2R_3) C_2}$$

Illustration is:

$f_L = 32 \text{ Hz}, f_{LB} = 320 \text{ Hz}$
 $f_H = 11 \text{ kHz}, f_{HB} = 1.1 \text{ kHz}$

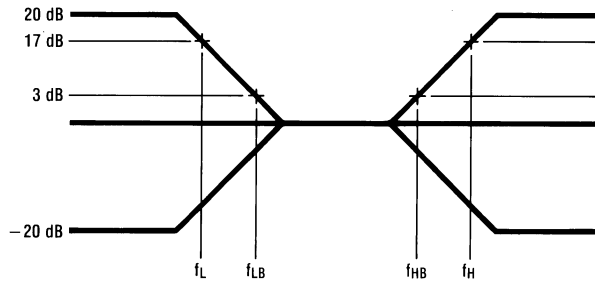

20157242

RIAA Preamp

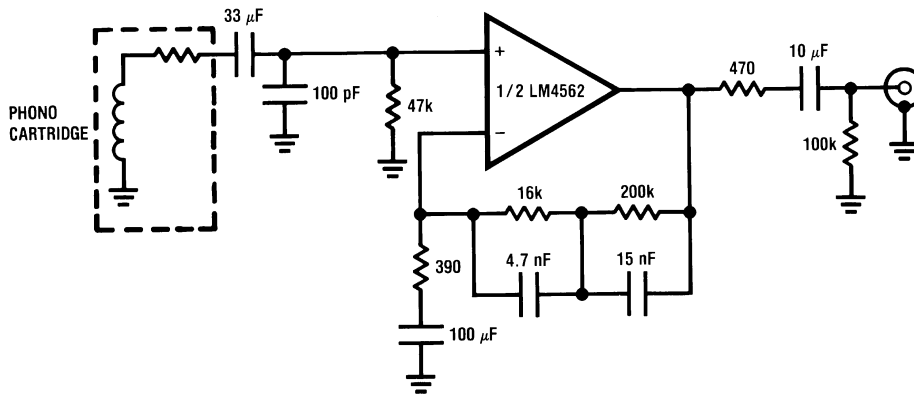

20157203

$A_v = 35 \text{ dB}$
 $E_n = 0.33 \mu\text{V}$
 $S/N = 90 \text{ dB}$
 $f = 1 \text{ kHz}$
 A Weighted
 A Weighted, $V_{IN} = 10 \text{ mV}$
 $@f = 1 \text{ kHz}$

Application Information (Continued)

Balanced Input Mic Amp

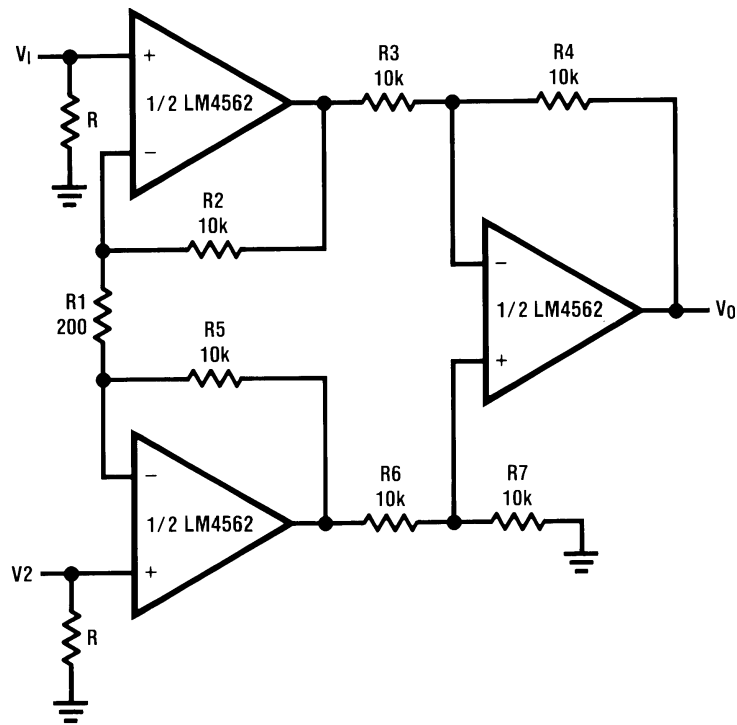

20157243

If $R2 = R5$, $R3 = R6$, $R4 = R7$

$$V_0 = \left(1 + \frac{2R_2}{R_1}\right) \frac{R_4}{R_3} (V_2 - V_1)$$

Illustration is:

$$V_0 = 101(V_2 - V_1)$$

Application Information (Continued)

10 Band Graphic Equalizer

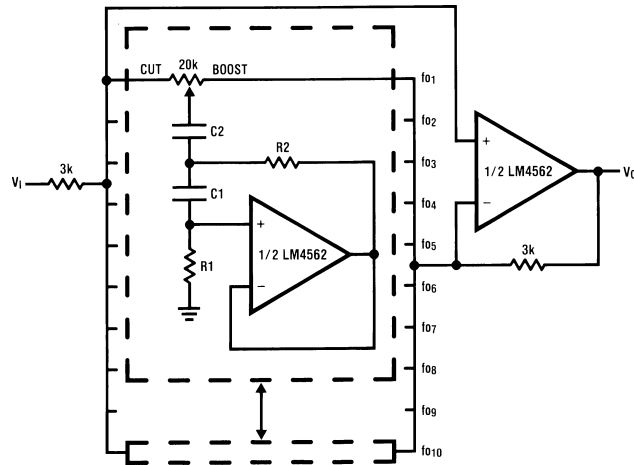

20157244

fo (Hz)	C ₁	C ₂	R ₁	R ₂
32	0.12 μ F	4.7 μ F	75k Ω	500 Ω
64	0.056 μ F	3.3 μ F	68k Ω	510 Ω
125	0.033 μ F	1.5 μ F	62k Ω	510 Ω
250	0.015 μ F	0.82 μ F	68k Ω	470 Ω
500	8200pF	0.39 μ F	62k Ω	470 Ω
1k	3900pF	0.22 μ F	68k Ω	470 Ω
2k	2000pF	0.1 μ F	68k Ω	470 Ω
4k	1100pF	0.056 μ F	62k Ω	470 Ω
8k	510pF	0.022 μ F	68k Ω	510 Ω
16k	330pF	0.012 μ F	51k Ω	510 Ω

Note 9: At volume of change = ± 12 dB

Q = 1.7

Reference: "AUDIO/RADIO HANDBOOK", National Semiconductor, 1980, Page 2-61

Revision History

Rev	Date	Description
0.05	5/24/05	Added edits and changes per TW Chan's and M Koterawasa-san's inputs and conference call (5/20/05). Changed part number to LM4562.
0.10	5/25/05	Updates based on inputs from design after KPC review.
0.15	10/5/05	Edited 201572 55 (pkg drwg) and added the M08A mktg outline.
0.20	11/01/05	Mjor edits on the EC table (by Heather).
0.25	02/02/06	Input major text (Typical limits) edits.
0.30	05/31/06	Some text edits.
0.35	06/07/06	Edited Typical values on Zin.
0.40	08/02/06	Added the Typ. Perf. Curves and some text edits.
0.45	08/07/06	Added the 2 curves (Voltage/Current Noise Density vs Freq.)
0.50	08/08/06	Replaced some of the curves.
0.55	08/10/06	Added more curves.
0.56	08/16/06	Initial WEB.
0.57	08/22/06	Changed the Typical values on Instantaneous Short Circuit Current from +30/-38 into +53/-42 (per Robin S.), then re-released the D/S to the WEB.

Physical Dimensions inches (millimeters) unless otherwise noted

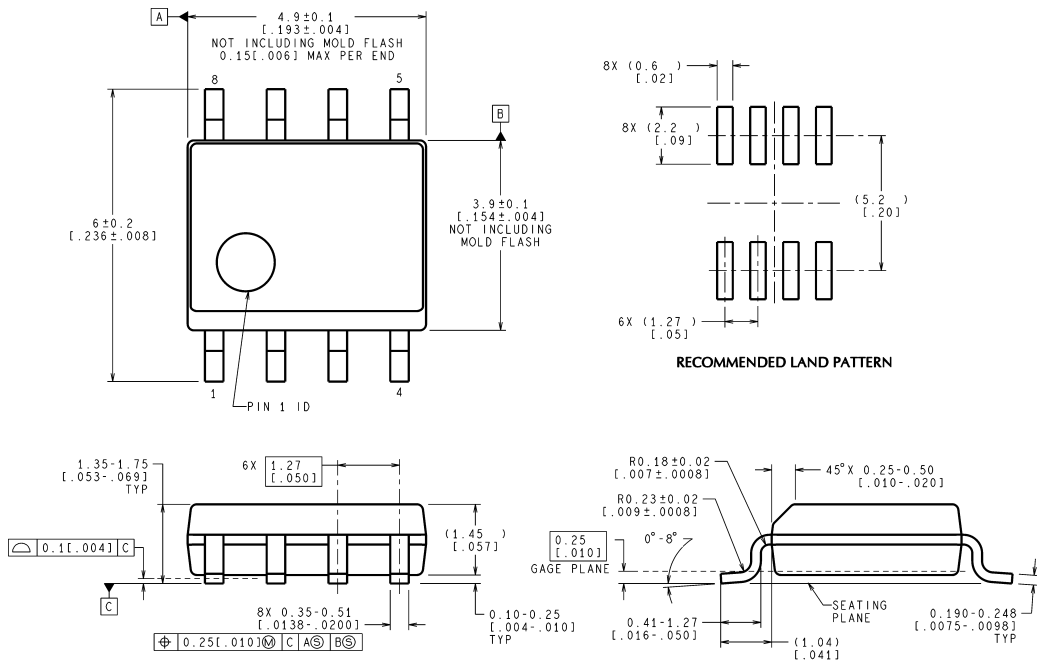

CONTROLLING DIMENSION IS MILLIMETER
VALUES IN [] ARE INCHES
DIMENSIONS IN () FOR REFERENCE ONLY

M08A (Rev K)

Narrow SOIC Package
Order Number LM4562MA
NS Package Number M08A

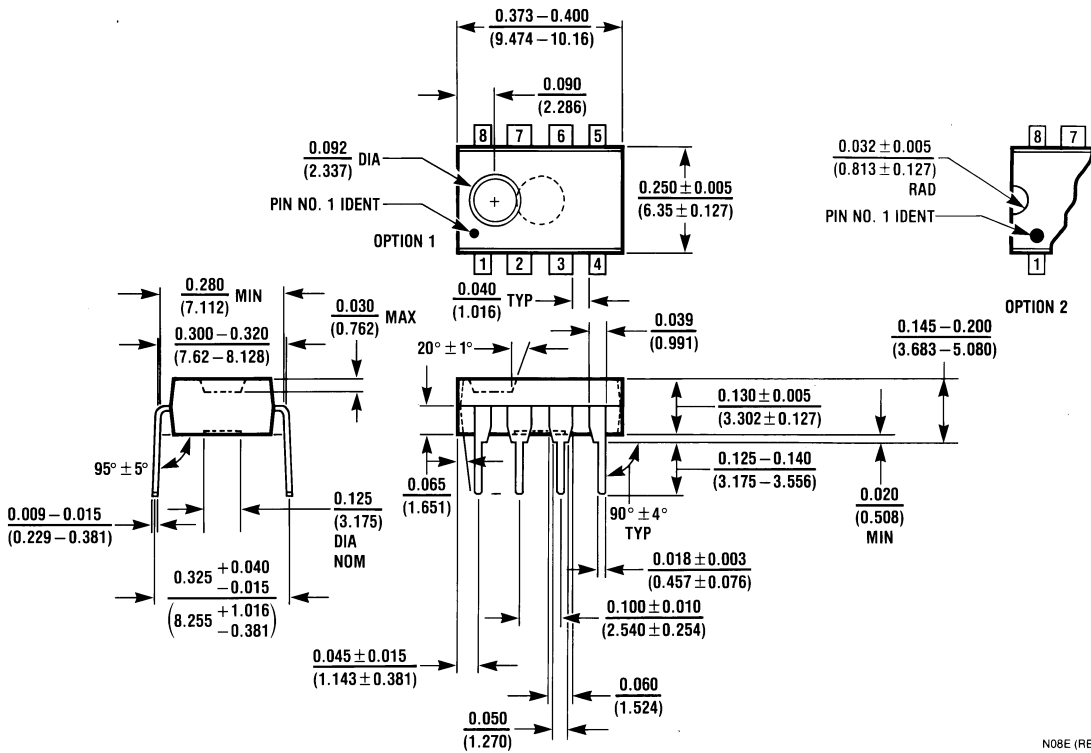

Dual-In-Line Package
Order Number LM4562NA
NS Package Number N08E

N08E (REV F)

Physical Dimensions inches (millimeters) unless otherwise noted (Continued)

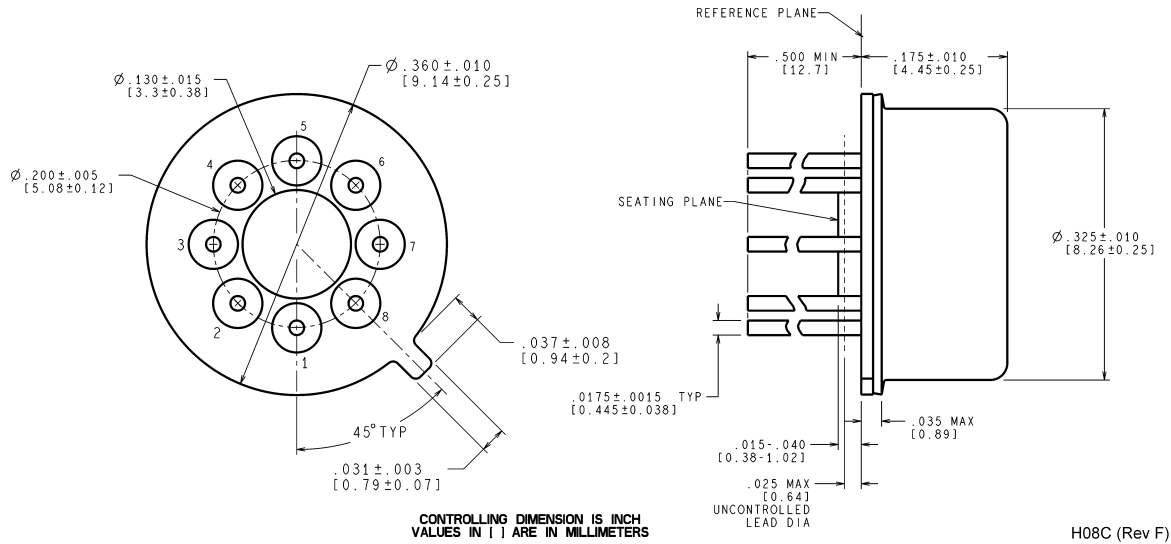

**TO-99 Metal Can Package
Order Number LM4562HA
NS Package Number H08C**

National does not assume any responsibility for use of any circuitry described, no circuit patent licenses are implied and National reserves the right at any time without notice to change said circuitry and specifications.

For the most current product information visit us at www.national.com.

LIFE SUPPORT POLICY

NATIONAL'S PRODUCTS ARE NOT AUTHORIZED FOR USE AS CRITICAL COMPONENTS IN LIFE SUPPORT DEVICES OR SYSTEMS WITHOUT THE EXPRESS WRITTEN APPROVAL OF THE PRESIDENT AND GENERAL COUNSEL OF NATIONAL SEMICONDUCTOR CORPORATION. As used herein:

1. Life support devices or systems are devices or systems which, (a) are intended for surgical implant into the body, or (b) support or sustain life, and whose failure to perform when properly used in accordance with instructions for use provided in the labeling, can be reasonably expected to result in a significant injury to the user.
2. A critical component is any component of a life support device or system whose failure to perform can be reasonably expected to cause the failure of the life support device or system, or to affect its safety or effectiveness.

BANNED SUBSTANCE COMPLIANCE

National Semiconductor follows the provisions of the Product Stewardship Guide for Customers (CSP-9-111C2) and Banned Substances and Materials of Interest Specification (CSP-9-111S2) for regulatory environmental compliance. Details may be found at: www.national.com/quality/green.

Lead free products are RoHS compliant.



National Semiconductor
Americas Customer
Support Center
Email: new.feedback@nsc.com
Tel: 1-800-272-9959

National Semiconductor
Europe Customer Support Center
Fax: +49 (0) 180-530 85 86
Email: europe.support@nsc.com
Deutsch Tel: +49 (0) 69 9508 6208
English Tel: +44 (0) 870 24 0 2171
Français Tel: +33 (0) 1 41 91 8790

National Semiconductor
Asia Pacific Customer
Support Center
Email: ap.support@nsc.com

National Semiconductor
Japan Customer Support Center
Fax: 81-3-5639-7507
Email: jpn.feedback@nsc.com
Tel: 81-3-5639-7560